



## Technical Specifications \*

Accuracy:	< 2% of FS range under constant conditions
Analysis:	0-1, 0-10, 0-100, 0-1000 PPM FS ranges Auto-ranging or manual lock on a single range
Application:	Oxygen analysis in inert, helium, hydrogen, mixed and non-acid (CO <sub>2</sub> ) gas streams
Approvals:	CE
Area Classification:	General purpose
Alarms:	Two user configurable alarms: magnetic coil relays rated 3A at 100 VAC, field programmable alarm time delays, alarm bypass for CAL and system fail alarm
Calibration:	Max interval—3 months. Use certified span gas with O <sub>2</sub> content (balance N <sub>2</sub> ) approximating 80% of full scale. For optimum accuracy, calibrate one range higher than the range of interest.
Compensation:	Barometric pressure and temperature
Connections:	1/8" compression tube fittings
Controls:	Water resistant keypad; menu driven range selection, calibration, alarm and system functions
Display:	<b>Graphical LCD 5" x 2.75"; resolution .001 PPM; displays real time ambient temperature and pressure</b>
Enclosure:	<b>Painted aluminum 6" x 4" x 4" panel mount</b>
Flow:	Sensitive; recommended flow rate 2 SCFH
Linearity:	> .995 over all ranges
Pressure:	Inlet - regulate to 5-30 psig to deliver 1-2 SCFH flow; vent - atmospheric
Power:	Universal; specify 100/120/220/240 VAC or 12-28 VDC
Range ID:	4-20mA non-isolated or 1-5V; option: relay contacts (eliminates alarms)
Recovery Time:	2 minutes at 9 PPM to 10 PPB in < 10 min on N <sub>2</sub> purge 30 seconds in air to < 1 PPM in < 45 min on N <sub>2</sub> purge
Response Time:	90% of final FS reading < 10 seconds
Sample System:	None
Sensitivity:	< 0.5% of FS range
Sensor Model:	GPR-12-2000MS for non-acid (CO <sub>2</sub> ) gas streams
Sensor Life:	24 months in < 100 PPM O <sub>2</sub> at 25°C and 1 atm
Signal Output:	4-20mA non-isolated or 1-5V
Temp. Range:	5°C to 45°C
Warranty:	12 months analyzer; 12 months sensor
Wetted Parts:	Stainless steel



## **GPR-1900 MS PPB Oxygen Analyzer**

Panel Mount Configuration for OEM Applications

### Advanced Sensor Technology

- Unmatched Performance in PPB O<sub>2</sub> Analysis
- Unmatched Expected Life & Warranty
- Unmatched Recovery to 10 PPB
- Sensitivity < 0.5% FS Range
- Fast Response
- No Maintenance

**100-240 VAC or 12-28 VDC Power**

**2 Field Selectable Alarm Setpoints**

**Power and System Failure Alarms**

**4 Ranges Standard**

**Auto Ranging or Single Fixed**

**4-20 mA or 1-5V Signal Output**

**Range ID 4-20 mA or Relay Contacts**

**Stainless Steel Wetted Parts**

## Optional Equipment

Sample conditioning accessories - contact factory

\* Specification subject to change without notice.

**ISO 9001:2008 Certified**  
**INTERTEK Certificate No. 485**



***GPR-1900 MS  
ppm Oxygen Analyzer***



Owner's Manual

# Table of Contents

<b>Introduction</b>	<b>1</b>
<b>Quality Control Certification</b>	<b>2</b>
<b>Safety</b>	<b>3</b>
<b>Features &amp; Specifications</b>	<b>4</b>
<b>Operation</b>	<b>5</b>
<b>Maintenance</b>	<b>6</b>
<b>Spare Parts</b>	<b>7</b>
<b>Troubleshooting</b>	<b>8</b>
<b>Warranty</b>	<b>9</b>
<b>Material Safety Data Sheets</b>	<b>10</b>
<b>Correlating reading - LCD display to 4-20mA output</b>	<b>Appendix B</b>

## 1 Introduction

Your new oxygen analyzer is a precision piece of equipment designed to give you years of use in variety of industrial oxygen applications.

This analyzer is designed to measure the oxygen concentration in inert gases, gaseous hydrocarbons, hydrogen, and a variety of gas mixtures. In order to derive maximum performance from your new oxygen analyzer, please read and follow the guidelines provided in this Owner's Manual.

The serial number of this analyzer may be found on the inside the analyzer. You should note the serial number in the space provided and retains this Owner's Manual as a permanent record of your purchase, for future reference and for warranty considerations.

Serial Number: \_\_\_\_\_

Every effort has been made to select the most reliable state of the art materials and components designed for superior performance and minimal cost of ownership. This analyzer was tested thoroughly by the manufacturer for best performance. However, modern electronic devices do require service from time to time. The warranty included herein plus a staff of trained professional technicians to quickly service your analyzer is your assurance that we stand behind every analyzer sold.

Advanced Instruments Inc. appreciates your business and pledge to make effort to maintain the highest possible quality standards with respect to product design, manufacturing and service.

## 2 Quality Control Certification

<b>Date:</b>	<b>Customer:</b>	<b>Order No.:</b>	<u><b>Pass</b></u>
<b>Model:</b>	GPR-1900MS ppm Oxygen Analyzer	<b>S/N</b> _____	_____
<b>Sensor:</b>	GPR-12-2000MS ppm Oxygen Sensor	<b>S/N</b> _____	_____
<b>Accessories:</b>	Owner's Manual CABL-1008 Power Cord		_____
<b>Configuration:</b>	Ranges: 0-1 ppm, 0-10 ppm, 0-100 ppm, 0-1000 ppm A-1161-A-5 PCB Assembly Main / Display <span style="float: right;"><b>Software V.</b> _____</span> <input type="checkbox"/> A-1162 PCB Assy Power Supply / Interconnection Alarms, 4-20mA Range ID <input type="checkbox"/> A-1175 PCB Assy Power Supply / Interconnection w/o Alarms, 5x Relays Range ID Power: <input type="checkbox"/> 100/120/220/250 VAC <input type="checkbox"/> 9-28 VDC non-loop Enclosure: <input type="checkbox"/> Panel mount 7W x 4"H x 4"D (panel cutout 6"W x 3"H) (GPR-1900MS-R) <input type="checkbox"/> Panel mounted with rear cover for 19" rack 19x7x12" (GPR-1900MS-W) <input type="checkbox"/> Door mounted for NEMA4 wall mount 12x12x8"		_____
	SS sensor housing and 1/8" compression type fittings for inlet and vent		_____
	<input type="checkbox"/> Optional sample system consisting of flow and bypass valves, and, flow indicator		_____
	<input type="checkbox"/> Optional temperature controlled heater system (requires -R or -W enclosure option)		_____
<b>Test</b>	System start-up diagnostics satisfactory		_____
	Auto/manual range		_____
	Alarm relays activate/deactivate with changes in O <sub>2</sub> concentration		_____
	Alarm bypass		_____
	Analog outputs: 4-20mA signal output		_____
	4-20mA range ID reflects range changes		_____
	Recovery from air to < 10 ppm in < 15 minutes		_____
	Baseline drift on zero gas < ± 2% FS over 24 hour period		_____
	Noise level < ± 1.0% FS		_____
	Span adjustment within 10-50% FS		_____
	Peak to peak over/under shoot < 0.5% FS		_____
	Overall inspection for physical defects		_____
<b>Options</b>	Label analyzer "Oxygen Service" in accordance with P-1507 Rev-1; see certificate next page.		_____
<b>Notes</b>			_____

# Certificate of Cleaning

## Oxygen Service

Standard: Manufacturing Procedure No. P-1057 Rev-1,  
Compressed Gas Association,  
Publication: G-4.1 Edition 4,  
Title: Cleaning Equipment for Oxygen Service,  
Published 1/1/1996 and related publications

Mfg. Item No.: GPR-1900MS Series  
Description: ppm Oxygen Analyzer

Serial No.: \_\_\_\_\_

Customer: \_\_\_\_\_

Purchase Order: \_\_\_\_\_

Quantity: 1 of \_\_\_\_\_

Warranty Date: 12 months from \_\_\_\_\_

The undersigned warrants on behalf of Manufacturer that the product identified above conforms to the manufacturing, testing and packaging criteria set forth by the 'Standard' specified above.

Date: \_\_\_\_\_

Place: Pomona, CA

By print name: \_\_\_\_\_

Signature: \_\_\_\_\_

Title: \_\_\_\_\_

## 3 Safety Guidelines

### Safety

This section summarizes the basic precautions applicable to all analyzers. Additional precautions specific to individual analyzer are contained in the following sections of this manual. To operate the analyzer safely and obtain maximum performance follow the basic guidelines outlined in this Owner's Manual.

**Caution:** This symbol is used throughout the Owner's Manual to **Caution** and alert the user to recommended safety and/or operating guidelines.

**Danger:** This symbol is used throughout the Owner's Manual to identify sources of immediate **Danger** such as the presence of hazardous voltages.

**Read Instructions:** Before operating the analyzer read the instructions.

**Retain Instructions:** The safety precautions and operating instructions found in the Owner's Manual should be retained for future reference.

**Heed Warnings Follow Instructions:** Follow all warnings on the analyzer, accessories (if any) and in this Owner's Manual. Observe all precautions and operating instructions. Failure to do so may result in personal injury or damage to the analyzer.

**Heat:** Situate and store the analyzer away from sources of heat.

**Liquid and Object Entry:** The analyzer should not be immersed in any liquid. Care should be taken so that liquids are not spilled into and objects do not fall into the inside of the analyzer.

**Handling:** Do not use force when using the switches and knobs. Before moving your analyzer be sure to disconnect the wiring/power cord and any cables connected to the output terminals located on the analyzer.

### Maintenance

**Serviceability:** Except for replacing the oxygen sensor, there are no parts inside the analyzer for the operator to service. Only trained personnel with the authorization of their supervisor should conduct maintenance.

**Oxygen Sensor:** DO NOT open the sensor. The sensor contains a corrosive liquid electrolyte that could be harmful if touched or ingested, refer to the Material Safety Data Sheet contained in this Owner's Manual. Avoid contact with any liquid or crystal type powder in or around the sensor or sensor housing, as either could be a form of electrolyte. Leaking sensors should be disposed of in accordance with local regulations.

**Troubleshooting:** Consult the guidelines in section 8 for advice on the common operating errors before concluding that your analyzer is faulty. Do not attempt to service the analyzer beyond those means described in this Owner's Manual.

Do not attempt to make repairs by yourself as this will void the warranty, as detailed by section 9, and may result in electrical shock, injury or damage. All other servicing should be referred to qualified service personnel.

**Cleaning:** The analyzer should be cleaned only as recommended by the manufacturer. Wipe off dust and dirt from the outside of the unit with a soft damp cloth then dry immediately. Do not use solvents or chemicals.

**Nonuse Periods:** Disconnect the power when the analyzer is left unused for a long period of time.

## Installation

**Gas Sample Stream:** Ensure the gas stream composition of the application is consistent with the specifications and review the application conditions before initiating the installation. Consult the factory to ensure the sample is suitable for analysis.

**Contaminant Gases:** A gas scrubber and flow indicator with integral metering valve are required upstream of the of the analyzer to remove interfering gases such as oxides of sulfur and nitrogen or hydrogen sulfide that can produce false readings, reduce the expected life of the sensor and void the sensor warranty if not identified at time of order placement. Installation of a suitable scrubber is required to remove the contaminant from the sample gas to prevent erroneous analysis readings and damage to the sensor or optional components. Consult the factory for recommendations concerning the proper selection and installation of components.

**Expected Sensor Life:** With reference to the publish specification located as the last page of this manual, the expected life of all oxygen sensors is predicated on oxygen concentration (< 1000 ppm or air), temperature (77°F/25°C) and pressure (1 atmosphere) in "normal" applications. As a rule of thumb sensor life is inversely proportional to changes in the parameters. Deviations are outside the specifications and will affect the life of the sensor, with respect to Pico-Ion sensors avoid exposure to oxygen levels above 1000 ppm. Failure to do will result in damage to the sensor.

**Accuracy & Calibration:** Refer to section 5 Operation. Analyzers equipped with Pico-Ion oxygen sensors have a maximum range of 0-1000 ppm reflecting its high signal output capability, DO NOT CALIBRATE THE GPR-1900MS WITH AMBIENT AIR.

**Materials:** Assemble the necessary zero, purge and span gases and optional components such as valves, coalescing or particulate filters, and, pumps as dictated by the application; stainless steel tubing is essential for maintaining the integrity of the gas stream for ppm and percentage range (above or below ambient air) analysis; hardware for mounting.

**Operating Temperature:** The sample must be sufficiently cooled before it enters the analyzer and any optional components. A coiled 10 foot length of ¼" stainless steel tubing is sufficient for cooling sample gases as high as 1,800°F to ambient. The maximum operating temperature is 45° C on an intermittent basis unless the user is willing to accept a reduction in expected sensor life – refer to analyzer specification - where expected sensor life is specified at an oxygen concentration less than 1000 ppm oxygen for ppm analyzers and air (20.9% oxygen) for percent analyzers, but in all instances at 25°C and 1 atmosphere of pressure. Expected sensor varies inversely with changes in these parameters.

### **Pressure & Flow**

All electrochemical oxygen sensors respond to partial pressure changes in oxygen. The sensors are equally capable of analyzing the oxygen content of a flowing sample gas stream or monitoring the oxygen concentration in ambient air (such as a confined space such a control room or open area such as a landfill or bio-pond). The following is applicable to analyzers equipped with Pico-Ion UHP and MS oxygen sensors, also refer to the analyzer's specifications.

**Caution:** The superior performance characteristics of the Pico-Ion Series oxygen sensor include:

- LDL (lower detectable limit) below 10 ppb,
- Excellent stability,
- Fast recovery from high oxygen upset conditions,
- 24 month operating life,
- No maintenance

- were achieved with minor trade-offs:

1. Slightly greater sensitivity (than our traditional fuel cell sensor) to changes in flow rate
2. Susceptibility to damage from vacuum generated by backpressure or use of a sampling pump as described below.
3. The high sensor output (required for ppb measurements) precludes air calibration or exposing the Pico-Ion sensor to air.

A flow rate of 1 SCFH @ 30 psig is recommended for optimal performance.

**Inlet Pressure:** Analyzers designed for flowing samples under positive pressure or pump vacuum (for samples at atmospheric or slightly negative atmospheres) that does not exceed 4" water column are equipped with bulkhead tube fitting connections on the side of the unit (unless otherwise indicated, either fitting can serve as inlet or vent) and are intended to operate at positive pressure regulated to between 20-50 psig although the rating of the fitting itself is considerably higher.

**Outlet Pressure:** In positive pressure applications the vent pressure must be less than the inlet, preferably atmospheric.

Sample systems and flowing gas samples are generally required for applications involving oxygen measurements at a pressure other than ambient air. In these situations, the use of stainless steel tubing and fittings is critical to maintaining the integrity of the gas stream to be sampled and the inlet pressure must always be higher than the pressure at the outlet vent which is normally at atmospheric pressure. Flow Through Configuration: The sensor is exposed to sample gas that must flow or be drawn through metal tubing inside the analyzer. The internal sample system includes 1/8" compression inlet and vent fittings, a stainless steel sensor housing with an o-ring seal to prevent the leakage of air and stainless steel tubing.

A flow indicator with an integral metering valve upstream of the sensor is recommended as a means of controlling the flow rate of the sample gas. For optimum performance, a flow rate of 1 SCFH at 30 psig is recommended.

**Caution:** Do not place your finger over the vent (it pressurizes the sensor) to test the flow indicator when gas is flowing to the sensor. Removing your finger (the restriction) generates a vacuum on the sensor and may damage the sensor (voiding the sensor warranty). To avoid generating a vacuum on the sensor (as described above) during operation, always select and install the vent fitting first and remove the vent fitting last.

**Application Pressure - Positive:** To reduce the possibility of leakage for low ppm measurements, position a metering needle valve upstream of the sensor to control the flow rate and position a flow indicator downstream of the sensor. If necessary, a pressure regulator (with a metallic diaphragm is recommended for optimum accuracy, the use of diaphragms of more permeable materials may result in erroneous readings) upstream of the flow control valve should be used to regulate the inlet pressure between 20-50 psig.

**Application Pressure - Atmospheric or Slightly Negative:** For accurate ppm range oxygen measurements, an optional external sampling pump should be positioned downstream of the sensor to draw the sample (vacuum should not exceed 4" water column) from the process, by the sensor and out to atmosphere. A flow meter is generally not necessary to obtain the recommended flow rate with most sampling pumps.

**Caution:** If the analyzer is equipped with an optional flow indicator with integral metering valve or a metering flow control valve upstream of the sensor - open the metering valve completely to avoid drawing a vacuum on the sensor and placing an undue burden on the pump.

If pump loading is a consideration, a second throttle valve on the pump's inlet side may be necessary to provide a bypass path so the sample flow rate is within the above parameters.

**Recommendations to avoid erroneous oxygen readings and damaging the sensor:**

- Do not place your finger over the vent (it pressurizes the sensor) to test the flow indicator when gas is flowing to the sensor. Removing your finger (the restriction) generates a vacuum on the sensor and may damage the sensor (thus voiding the sensor warranty).
- Assure there are no restrictions in the sample or vent lines
- Avoid drawing a vacuum that exceeds 4" of water column pressure – unless done gradually
- Avoid excessive flow rates above 3 SCFH which generate backpressure on the sensor.
- Avoid sudden releases of backpressure that can severely damage the sensor.
- Avoid the collection of liquids or particulates on the sensor, they block the diffusion of oxygen into the sensor - wipe away.
- If the analyzer is equipped with an optional integral sampling pump (positioned downstream of the sensor) and a flow control metering valve (positioned upstream of the sensor), completely open the flow control metering valve to avoid drawing a vacuum on the sensor and placing an undue burden on the pump.

**Moisture & Particulates:** Installation of a suitable coalescing or particulate filter is required to remove condensation, moisture and/or particulates from the sample gas to prevent erroneous analysis readings and damage to the sensor or optional components. Moisture and/or particulates do not necessarily damage the sensor, however, collection on the sensing surface can block or inhibit the diffusion of sample gas into the sensor resulting in a reduction of sensor signal output – and the appearance of a sensor failure when in fact the problem is easily remedied by blowing on the front of the sensor. Consult the factory for recommendations concerning the proper selection and installation of components.



Moisture and/or particulates generally can be removed from the sensor by opening the sensor housing and either blowing on the sensing surface or gently wiping or brushing the sensing surface with damp cloth. **Caution:** Minimize the exposure of ppm sensors to air during this cleaning process. Air calibration followed by purging with zero or a gas with a low ppm oxygen concentration is recommended following the cleaning process. Moisture and/or particulates generally can be removed from the sample system by flowing the purge gas through the analyzer at a flow rate of 4.5-5 SCFH for an hour.

**Mounting:** The analyzer is approved for indoor use, outdoor use requires optional enclosures, consult factory. Mount as recommended by the manufacturer.

**Gas Connections:** Inlet and outlet vent gas lines for ppm analysis require 1/8" or 1/4" stainless steel compression fittings; hard plastic tubing with a low permeability factor can be used percentage range measurements.

**Power:** Supply power to the analyzer only as rated by the specification or markings on the analyzer enclosure. The wiring that connects the analyzer to the power source should be installed in accordance with recognized electrical standards. Ensure that is properly grounded and meets the requirements for area classification. Never yank wiring to remove it from a terminal connection. AC powered analog analyzers consume 5 watts, digital analyzers 50 watts without optional heaters. Optional 110V and 220V heaters AC powered heaters consume an additional 100-150 watts; DC powered digital analyzers consume 30 watts, 40 watts with the optional DC powered heater.

## 4 Features & Specifications

Specifications are subject to change without notice. See last page for current specifications, this section left blank intentionally.

## 5 Operations

### Principle of Operation

The GPR-1900MS Series ppm Oxygen Analyzers incorporates a proprietary Pico-Ion oxygen sensor. It is configured for panel mounting and requires a 6"W x 3"H cutout with 4 holes for the studs located on the back side of the analyzer's front panel.

Optional mounting configurations include a 19" rack or wall mount enclosure with or without a sample system. Contact the factory for additional information on options. All configurations incorporate an analyzer module that has been tested and calibrated by the manufacturer prior to shipment. The GPR-1900MS Series analyzers are CE certified and manufactured along with the sensors under a Quality Assurance System certified by an independent agency to ISO 9001:2000 standards. However, the main feature remains the:

#### Breakthrough Sensor Technology:

A breakthrough sensor technology measures the partial pressure of oxygen from less than 10 ppb to 1000 ppm level in inert gases, gaseous hydrocarbons, helium, hydrogen and mixed gas streams. The "Pico-Ion" sensor design and chemistry have been combined to produce a significant advancement in oxygen sensor technology.

### Pico-Ion 'MS' Oxygen Sensor

#### Design Criteria

The evolution of electronics influences virtually every aspect of our personal and business lives. The world of industrial gas analyzers is no exception. However, often overlooked is the fact that the heart of any analyzer is the sensor. Thus advancing the sensor technology is a critical element in the development of analyzers.

- Proprietary metal catalyzed cathode . . .
  - High signal output 10x greater than galvanic sensors
  - High signal to noise ratio
  - Fast response time

- Maximize the rate oxygen is reacted . . .
- Minimize oxygen dissolving into electrolyte

- Fast recovery from exposure to oxygen

O <sub>2</sub> Exposure	Duration	O <sub>2</sub> Target	Recovery
Air	30 sec	10 ppm	15 min
Air	30 sec	1 ppm	45 min
9 ppm	2 min	100 ppb	3 min
9 ppm	2 min	10 ppb	10 min
1 ppm	5 min	10 ppb	15 min

- Lower detectable limit < 10 ppb
- High accuracy and repeatability < ±1%
- Employ a water evaporation limiting barrier
- Employ a barrier to limit the amount of oxygen dissolving into electrolyte
- Operating life minimum 36 month target
- No sensor maintenance
- Compact disposable design
- Long term stability less than 5% drift from span over 6 months
- Extended intervals between calibration minimum 3 months to 6 month target
- Readily transportable and insensitive to minor mechanical shock
- Low cost of ownership

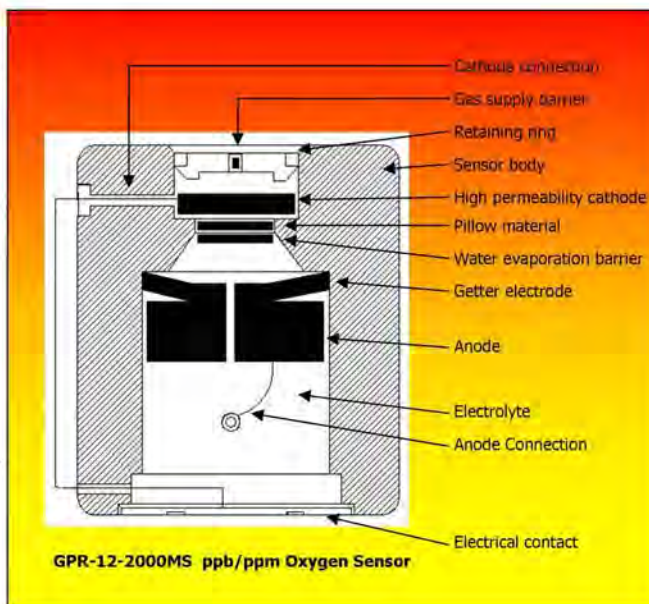

Oxygen, the fuel for this electrochemical transducer, reacts chemically at the sensing electrode to produce an electrical current output proportional to the oxygen concentration in the gas phase. The sensor's signal output is linear over all four ranges and remains virtually constant over its useful life. The sensor requires no maintenance or electrolyte addition and is easily and safely replaced at the end of its useful life.

## Electronics

The signal generated by the sensor is processed by state of the art low power micro-processor based digital circuitry. The first stage amplifies the signal. The second stage eliminates the low frequency noise. The third stage employs a high frequency filter and compensates for signal output variations caused by ambient temperature changes. The result is a very stable signal.

Sample oxygen is analyzed very accurately. Response time of 90% of full scale is less than 10 seconds (actual experience may vary due to the integrity of sample line connections, dead volume and flow rate selected) on all ranges under ambient monitoring conditions. Sensitivity is typically 0.5% of full scale low range.

Additional features of the micro-processor based electronics include manual or auto ranging, isolated 4-20mA signal for signal output and range ID, alarm contacts are also available for the range ID feature. Whenever the analyzer is calibrated, a unique algorithm predicts and displays a message indicating a 'weak sensor' suggesting the sensor be replaced in the near future.

## Sample System

In standard form the GPR-1900MS is designed to be integrated into a larger analyzer system and provide users with maximum flexibility, and, therefore is not equipped with a sample system. The sample must be properly presented to the sensor to ensure an accurate measurement. Users interested in adding their own sample conditioning system should consult the factory. Advanced Instruments Inc. offers a full line of sample handling, conditioning and expertise to meet your application requirements. Contact us at 909-392-6900 or e-mail us at [info@a11.com](mailto:info@a11.com).

An optional sample system complements the performance capabilities of the Pico-Ion oxygen sensor and enables the user to isolate the sensor from exposure to high oxygen concentration which results in a substantial increase in user productivity. This bypass feature has two important features: one, the sensor can be isolated from exposure to high oxygen levels when changing sample lines, during transport and during standby intervals making it ideal for mobile cart applications. Two, it enables the user to purge newly connected gas lines of the oxygen trapped inside. The result is an analyzer that comes on-line at ppb levels in a matter of minutes and provides users with a significant increase in productivity.

For ppb and ppm trace oxygen measurements, the sensor is exposed to sample gas that must flow or be drawn through the analyzer's internal sample system. This unique sample system, when operated accordingly to the instructions in this Owner's Manual, can significantly increase user productivity by minimizing the sensor's exposure to ambient air or high oxygen concentrations which contribute to the significant amount of downtime associated with competitive analyzers.

## BYPASS SAMPLE SYSTEM: MS Sensor

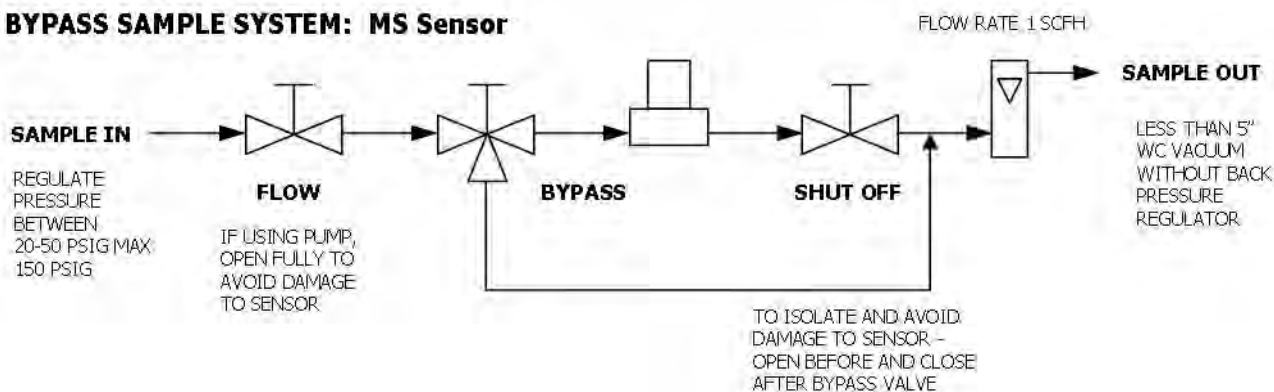

The advantages of the bypass sample system include:

- Supplying the analyzer with the sensor it was qualified with.
- Isolating the sensor during transport, calibration and maintenance intervals when changing gas line connections.
- Isolating the sensor from exposure to high oxygen levels during upset conditions which extends sensor life.
- Purging the air (or high oxygen levels above 1,000 ppm) trapped in the gas lines following a process upset.

Advanced Instruments Inc. offers a full line of sample handling, conditioning and expertise to meet your application requirements. Contact us at 909-392-6900 or e-mail us at [info@aii1.com](mailto:info@aii1.com)

## Calibration & Accuracy Overview

**Single Point Calibration:** As previously described the galvanic oxygen sensor generates an electrical current proportional to the oxygen concentration in the sample gas. In the absence of oxygen the sensor exhibits an absolute zero, e.g. the sensor does not generate a current output in the absence of oxygen. Given these linearity and absolute zero properties, single point calibration is possible.

**Pressure:** Because sensors are sensitive to the partial pressure of oxygen in the sample gas their output is a function of the number of molecules of oxygen 'per unit volume'. Readouts in percent are permissible only when the total pressure of the sample gas being analyzed remains constant. The pressure of the sample gas and that of the calibration gas(es) must be the same (reality < 1-2 psi).

**Temperature:** The rate oxygen molecules diffuse into the sensor is controlled by a Teflon membrane otherwise known as an 'oxygen diffusion limiting barrier' and all diffusion processes are temperature sensitive, the fact the sensor's electrical output will vary with temperature is normal. This variation is relatively constant 2.5% per °C. A temperature compensation circuit employing a thermistor offsets this effect with an accuracy of  $\pm 5\%$  or better and generates an output function that is independent of temperature. There is no error if the calibration and sampling are performed at the same temperature or if the measurement is made immediately after calibration. Lastly, small temperature variations of 10-15° produce < 1% error.

**Accuracy:** In light of the above parameters, the overall accuracy of an analyzer is affected by two types of errors: 1) those producing 'percent of reading errors', illustrated by Graph A below, such as  $\pm 5\%$  temperature compensation circuit, tolerances of range resistors and the 'play' in the potentiometer used to make span adjustments and 2) those producing 'percent of full scale errors', illustrated by Graph B, such as  $\pm 1-2\%$  linearity errors in readout devices, which are really minimal due to today's technology and the fact that other errors are 'spanned out' during calibration.

Graph C illustrates these 'worse case' specifications that are typically used to develop an analyzer's overall accuracy statement of < 1% of full scale at constant temperature or < 5% over the operating temperature range. QC testing is typically < 0.5% prior to shipment.

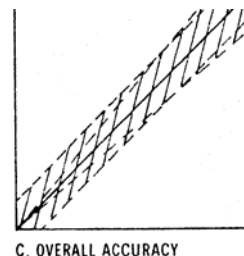
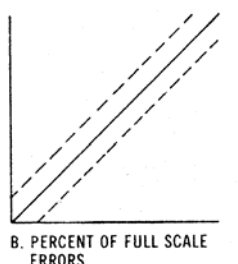
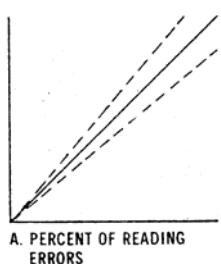
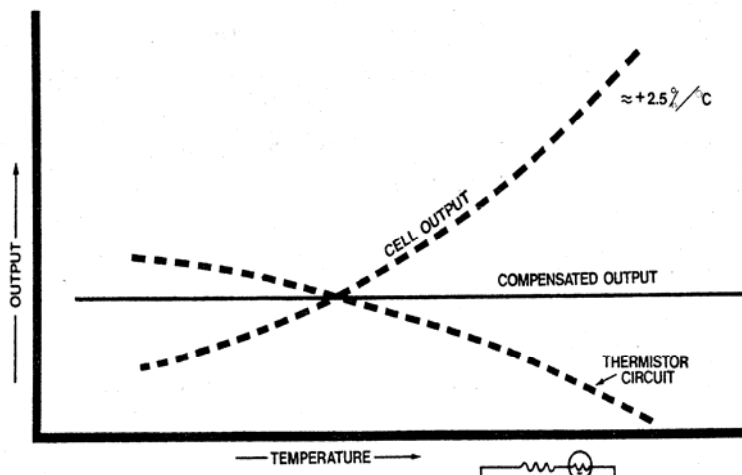

**Example 1:** As illustrated by Graph A any error, play in the multi-turn span pot or the temperature compensation circuit, during a span adjustment at 20.9% (air) of full scale range would be multiplied by a factor of 4.78 (100/20.9) if used for measurements of 95-100% oxygen concentrations. Conversely, an error during a span adjustment at 100% of full scale range is reduced proportionately for measurements of lower oxygen concentrations.

## Zero Calibration

In theory, the galvanic fuel cell type oxygen has an absolute zero meaning it produces no signal output when exposed to an oxygen free sample gas. In reality, expect the analyzer to generate an oxygen reading when sampling a zero gas due to:

- Contamination or quality of the zero gas
- Minor leakage in the sample line connections
- Residual oxygen dissolved in the sensor's electrolyte
- Tolerances of the electronic components

The Zero Offset capability of the analyzer is limited to 50% of lowest most sensitive range available with the analyzer.

As part of our Quality Control Certification process, the zero capability of every ppm analyzer is qualified prior to shipment. However, because the factory sample system conditions differ from that of the user, no ZERO OFFSET adjustment is made to analyzer by the factory

## Recommendations:

- Zero calibration is recommended only for online analyzers performing continuous analysis below 5% of the lowest most sensitive range available with a ppm analyzer, e.g. analysis below 0.05 ppm on the 0-1 ppm range, 0.5 ppm on the 10 ppm range, or below 0.1% (1000 ppm) with a percent analyzer.
- Determining the true Zero Offset requires approximately 24 hours to assure the galvanic fuel cell sensor has consumed the oxygen that has dissolved into the electrolyte inside the sensor while exposed to air or percentage levels of oxygen. Allow the analyzer to stabilize with flowing zero gas as evidenced by a stable reading or horizontal trend on an external recording device. For optimum accuracy, utilize as much of the actual sample system as possible.
- Zero calibration is not practical and not recommended for portable analyzers or measurements on higher ranges. However, satisfying these users that the zero offset is acceptable for their application without the 24 hour wait can be accomplished by introducing a zero gas (or sample gas with a low ppm oxygen concentration) to the analyzer. Unless the zero gas is contaminated or there is a significant leak in the sample connections, the analyzer should read less than 100 ppm oxygen within 10 minutes after being placed on zero gas thereby indicating it is operating normally.
- Zero calibration should precede span calibration.
- Initiate the DEFAULT ZERO and DEFAULT SPAN procedures before performing either a ZERO or SPAN CALIBRATION.
- **Caution:** Prematurely initiating the ZERO CALIBRATION function can result in negative readings near zero.
- Once the zero offset adjustment is made, zero calibration is normally not required again until the sample system connections are modified, or, when installing a new oxygen sensor.

## Span Calibration

Span Calibration involves adjusting the transmitter electronics to the sensor's signal output at a given oxygen standard. Maximum drift from calibration temperature is approximately 0.11% of reading per °C. The frequency of calibration varies with the application conditions, the degree of accuracy required by the application and the quality requirements of the user. However, the interval between span calibrations should not exceed three (3) months.

**Note:** Regardless of the oxygen concentration of the standard used, the span calibration process takes approximately 10 minutes, however, the time required to bring the analyzer back on-line can vary depending on a combination of factors and assume exposure to a zero/purge/sample gas\*\* with an oxygen content below the stated thresholds immediately after span calibration:

Galvanic Sensor *	Oxygen Standard	Time Required to Come On-line**
O <sub>2</sub> levels above 1000 ppm / 0.1%	Air (209,000 ppm / 20.9%)	< 5 minutes
O <sub>2</sub> levels above 100 ppm	Air (209,000 ppm / 20.9%)	< 10 minutes
O <sub>2</sub> levels below 10 ppm	Air (209,000 ppm / 20.9%)	< 60 minutes for install or replacement < 30 minutes if in ppm service for > 1 week
O <sub>2</sub> levels below 10 ppm	800 ppm Certified Span Gas	< 5 minutes
O <sub>2</sub> levels below 10 ppm	80 ppm Certified Span Gas	< 1 minute

\* Refer to analyzer specifications for comparable data on the Pico-Ion UHP and MS oxygen sensors.

## Recommendations General:

- The interval between span calibrations should not exceed three (3) months.
- Initiate the DEFAULT ZERO and DEFAULT SPAN procedures before performing either a ZERO or SPAN CALIBRATION.
- **Caution:** Prematurely initiating the SPAN CALIBRATION function before the analyzer reading has stabilized can result in erroneous readings. This is especially true when installing a new sensor that must adjust to the difference in oxygen concentrations. It should take about 2 minutes for the sensor to equilibrate in ambient air from storage packaging.
- Always calibrate at the same temperature and pressure of the sample gas stream.
- For 'optimum calibration accuracy' calibrate with a span gas approximating 80% of the full scale range or a higher range than the full scale range of interest (normal use) to achieve the effect of "narrowing the error" by moving downscale as illustrated by Graph A in the Accuracy & Calibration section.
- Calibrating with a span gas approximating 5-10% of the full scale range near the expected oxygen concentration of the sample gas is acceptable but less accurate than 'optimum calibration accuracy' method recommended – the method usually depends on the gas available.
- Calibrating at the same 5-10% of the full scale range for measurements at the higher end of the range (example: calibrating an Oxygen Purity Analyzer in air at 20.9% oxygen with the intention of measuring oxygen levels of 50-100%) results in the effect of "expanding the error" by moving upscale as illustrated by Graph A and Example 1 in the Accuracy & Calibration section above and is not recommended. Of course the user can always elect at his discretion to accept an accuracy error of  $\pm 2-3\%$  of full scale range if no other span gas is available.

## Recommendations Air Calibration:

- Do not calibrate an analyzer employing the Pico-Ion UHP or MS sensor, or, an oxygen purity sensor with air.
- The inherent linearity of the galvanic fuel cell type oxygen sensor enables the user to calibrate any analyzer (except those using UHP or MS Pico-Ion sensors or intended for oxygen purity analysis) with ambient air (20.9% oxygen) and operate the analyzer within the stated accuracy spec on the lowest most sensitive range available with the analyzer – it is not necessary to recalibrate the analyzer with span gas containing a lower oxygen concentration.
- When installing or replacing a ppm or percent oxygen sensor.
- To verify the oxygen content of a certified span gas.
- When certified span gas is not available to calibrate a ppm analyzer (immediately following air calibration reintroduce a gas with a low oxygen concentration to expedite the return to ppm level measurements as described above \*\*).

## Mounting the Analyzer & Sensor

The GPR-1900MS consists of a six (6) foot insulated cable which connects the sensor to the rear of the electronics module, a long life maintenance free oxygen sensor and a stainless steel sensor housing equipped with 1/8" diameter stainless steel compression fittings.

The compact design also lends itself to optional mounting configuration such as a standard 19" rack or wall mount enclosures, both of which can be equipped with optional sample system components. Contact the factory for additional information.

### Procedure:

1. The GPR-1900MS front panel measures 7"W x 4"H x 4.5"D. This compact configuration is designed for panel mounting directly to any flat vertical surface, wall or bulkhead plate with the appropriate 6"W x 3"H cut out and four 1/4" diameter holes for insertion of the mounting studs located on the back side of the front panel.
2. When mounting the analyzer position it approximately 5 feet off the floor for viewing purposes and allow sufficient room for access to the terminal connections at the rear of the enclosure.



3. **Note:** The proximity of the analyzer to the sample point and use of optional sample conditioning components have an impact on sample lag time.
4. Position the sensor housing along any flat surface. The bracket attached to the sensor housing is fabricated with two 6/32 mounting holes. The oxygen sensor is not position sensitive but it is recommended to orient the sensor housing with the upper section identified by the interconnection cable facing the ceiling.
5. Connect the four wires of the cable, following the color coding above the terminal block, at the rear of the analyzer.
6. Attach the flow housing to the mounting position determine above.
7. Do not install the sensor at this time, see below.

## Mounting GPR-1900MS-R Option:

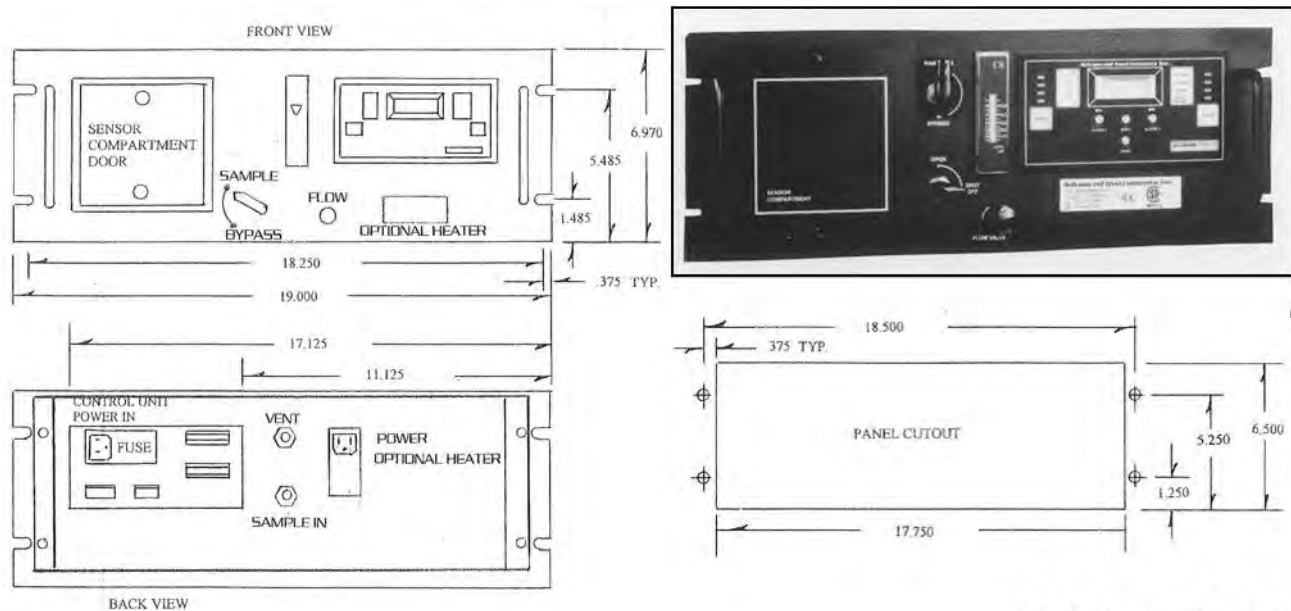

**Reference: B-2451**



## Mounting GPR-1900MS-W Option:

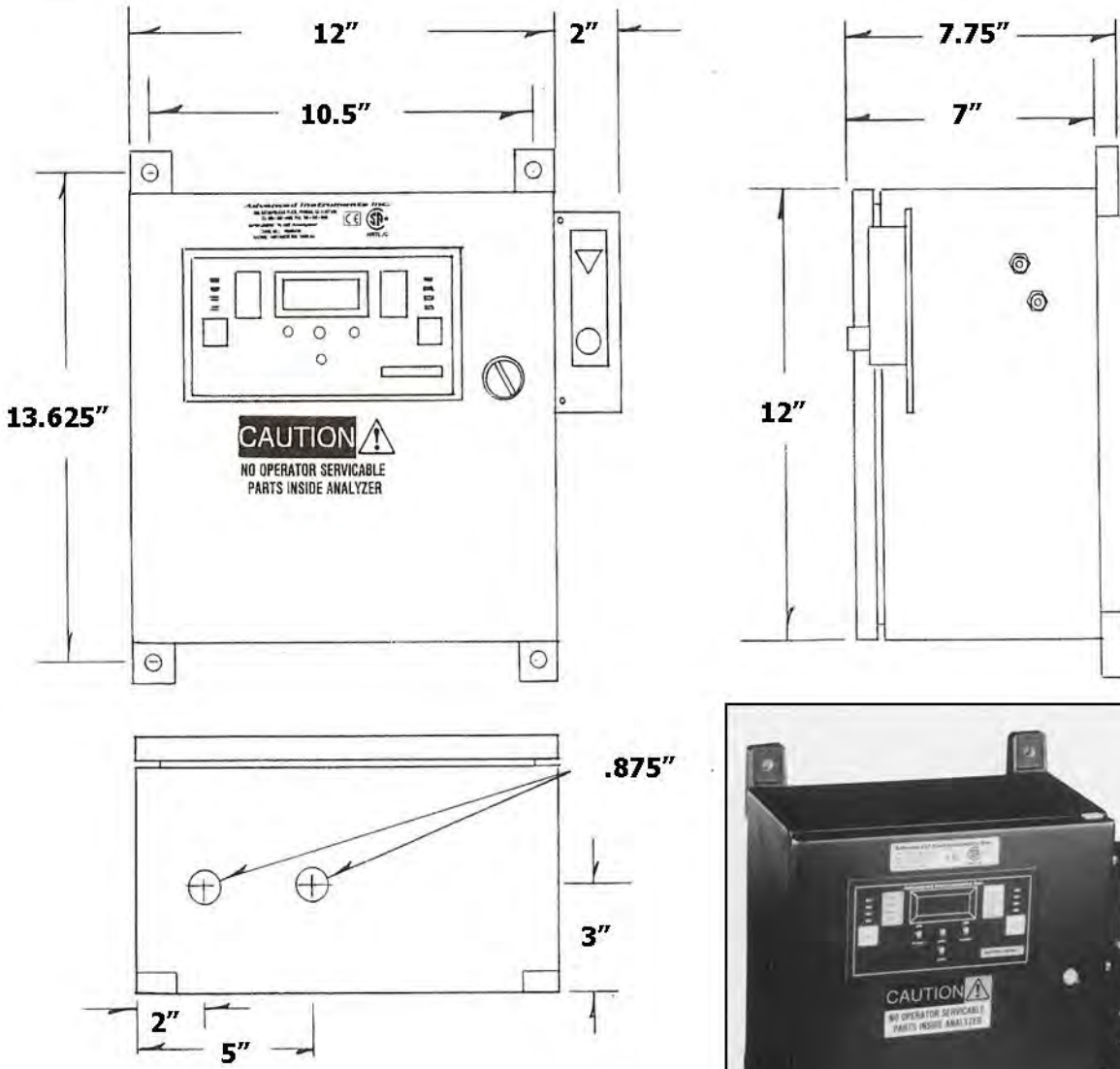

Reference: B-2453



## Gas Connections

The GPR-1900MS with its standard flow through configuration is designed for positive pressure samples and requires connections for incoming sample and outgoing vent lines. The user is responsible for calibration gases and the required components, see below. Flow rates of 1-3 SCFH cause no appreciable change in the oxygen reading. A flow indicator with an integral metering valve upstream of the sensor is recommended as a means of controlling the flow rate of the sample gas. A flow rate of 1 SCFH is recommended for optimum performance.

**Caution:** Do not place your finger over the fitting designated as the vent (it pressurizes the sensor) or to test the flow indicator when gas is flowing to the sensor. Removing your finger (the restriction) generates a vacuum on the sensor and may damage the sensor (voiding the sensor warranty).



### Procedure:

1. **Caution:** Do not change the factory setting until instructed.
2. Designate the female quick disconnect fittings, right side of the analyzer, as inlet and vent respectively.
3. Regulate the pressure and flow as described in Pressure & Flow above.
4. Install one mating male vent fitting into the female quick disconnect fitting designated as the VENT – connection of 1/8" dia. metal vent line (requires an 1/8" male NPT to tube adapter) is optional.
5. Connect the second mating male fitting to 1/8" dia. metal sample line using a 1/8" male NPT to tube adapter.
6. Connect the third mating male fitting to 1/8" dia. metal span gas line using a 1/8" male NPT to tube adapter.
7. Install either the sample or span mating male fitting into the female quick disconnect fitting designated as SAMPLE.
8. Set the flow rate to 2 SCFH (open the flow control valve completely if using an external sampling pump positioned downstream of the sensor).
9. Allow gas to flow through the analyzer for 3-5 minutes and proceed to Calibration or Sampling.

### GPR-1900MS-R Option:



### GPR-1900MS-W Option:

See above mounting diagram.

## Electrical Connections:

The appropriate AC or DC power requirement must be specified at order placement.

Incoming power for the 100-250V AC powered analyzers is supplied through a universal power entry module. A standard computer type power cord (P/N A-1008) is required for the universal power entry module. DC power cable must be supplied by the user. A well grounded insulated power cable is recommended to avoid noise resulting from unwanted interference. Power consumption is approximately 30 watts.

Filtered terminal blocks are provided for power failure, set point alarm relays and signal output connections. The PCB also includes a transformer to power the relays, a sensor bypass switch for troubleshooting the electronics

**Caution:** Integral 4-20mA converters are internally powered and do not require external power. DO NOT supply any voltage to any of the terminals for 4-20mA signal output and range ID or **the 4-20mA converters will be damaged.**

**Caution:** To assure proper grounding, connect the 4-20mA signal output to the external device (PLC, DCS, etc.) before attempting any zero or span adjustments.

### Optional Range ID:

The standard 4-20mA output used for range identification, as described below, can be replaced by eliminating the alarms feature and using the relay contacts associated with the alarms to provide a single common and four (4) normally open relay contacts that close when the related range is active. The dry contacts are rated at 30VDC @ 1A and powering them is optional as some PLCs can distinguish contact closure via continuity check.

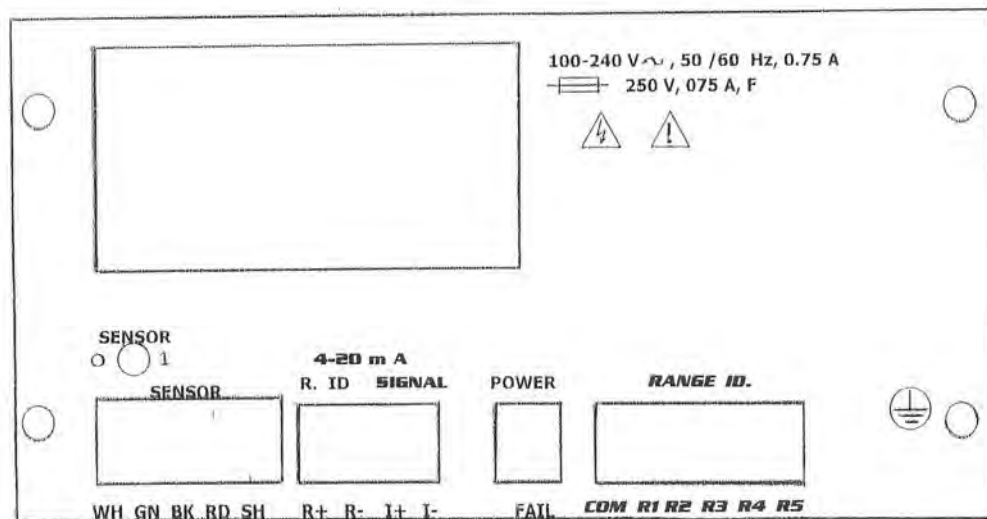

Reference: A-3446

### Procedure:

1. As illustrated above the sensor, power and alarm relays and signal output connections are hard wired to screw type terminal blocks located at the rear of the analyzer.
2. Use a small bladed screwdriver to loosen the appropriate terminal screws as illustrated above.
3. Strip the wires of the cable no more than 3/16 inch.
4. To connect to an active relay or "fail safe", connect the live cable to the common terminal C and the secondary cable to the normally open NO terminal.

# Advanced Instruments Inc.

5. To break the connection upon relay activation, connect the secondary cable to the normally closed NC terminal.
6. Insert the stripped end of the cables into the appropriate terminal slots assuring no bare wire remains exposed that could come in contact with the back panel of the analyzer enclosure.
7. Tighten the terminal screws to secure the wires of the cable.

**Danger:** While connecting the cables to the relay terminals, ensure there is no voltage on the cables to prevent electric shock and possible damage to the analyzer. **Caution:** Assure the stripped wire ends of the cable are fully inserted into the terminal slots and do not touch each other or the back panel of the analyzer enclosure.

**Optional Temperature Controlled Heater System (requires optional 19" rack or wall mount enclosures):**

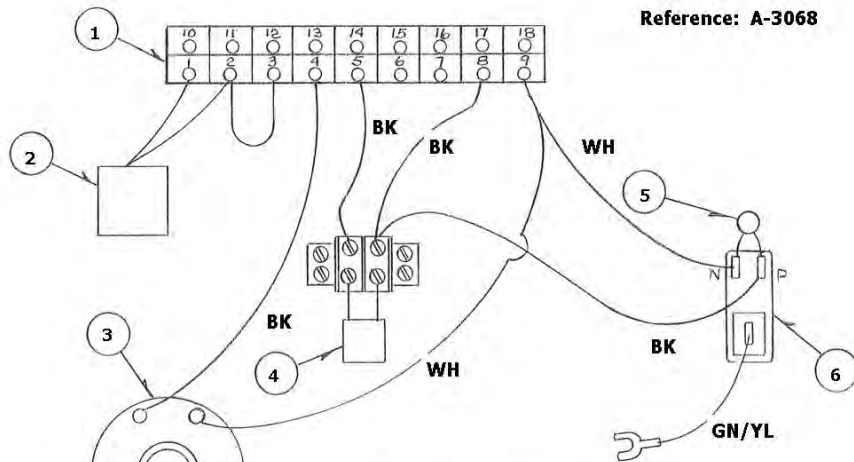

Reference: A-3068

REF	ITEM NO.	DESCRIPTION
1.	CTRL-1004	Temperature Controller
2.	SNSR-1001	RTD Temperature Sensor
3.	HTR-1002	Heater Disc
4.	SNSR-1002	PEPI Thermal Protector
5.	IC-1029	MOV Surge Protector
6.	PWRS-1005	Power Entry Module 100-240VAC



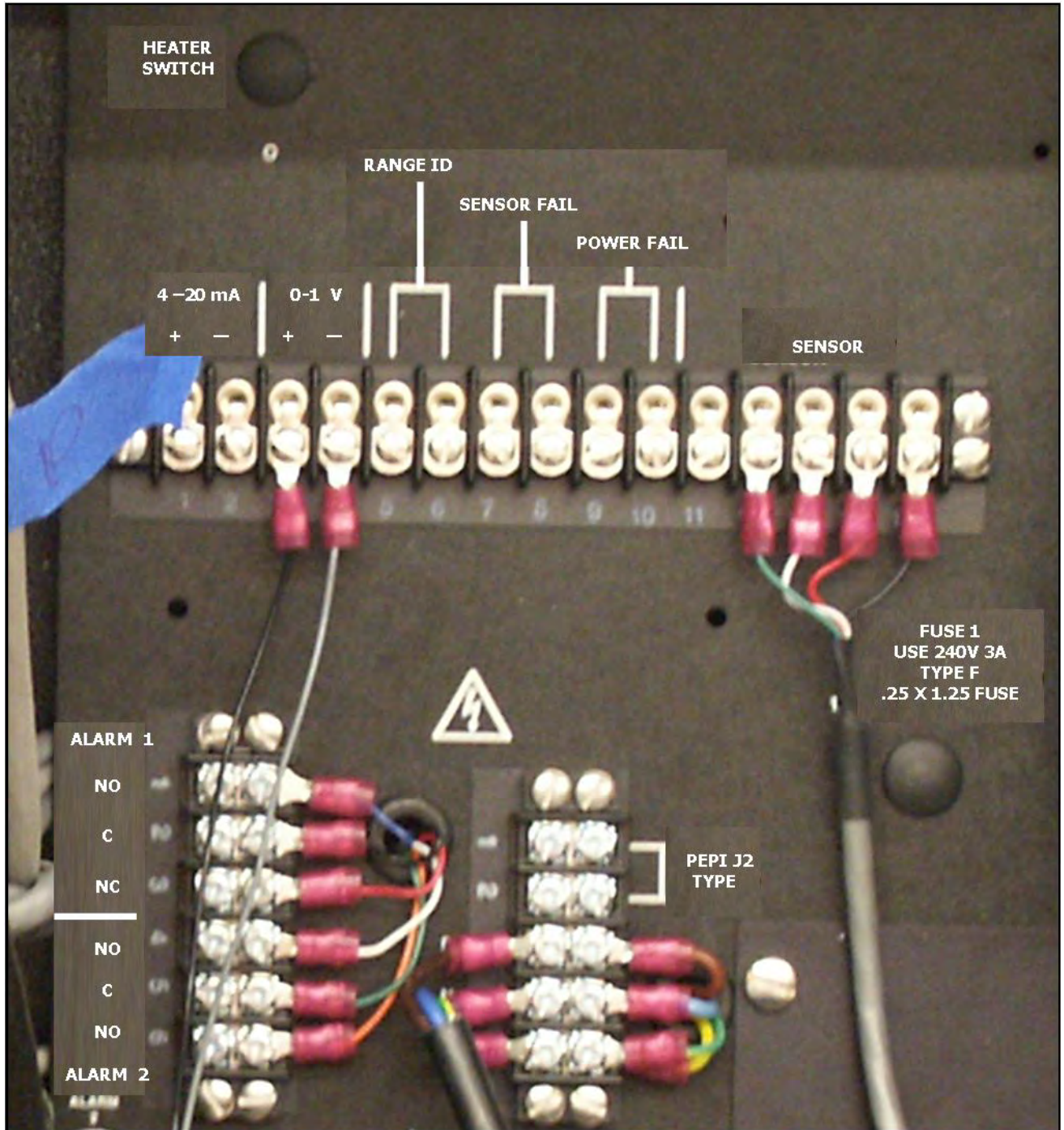

**Note:** Interconnections for the optional wall mount enclosure pictured above.

## **Alarms**

Alarm 1 and Alarm 2 represent two threshold type alarms that can be configured in the field from the analyzer's menu driven LCD display as follows:

- Establish independent set points
- Either Hi or Lo
- Either On or Off (enabled or disabled)
- Both temporarily defeated using a user entered 'timeout' period (normally minutes)

The alarm set point represents a value. When the oxygen reading exceeds (high alarm) or falls below (low alarm) the alarm set point, the relay is activated and the LCD displays the alarm condition. When activated the alarms trigger SPDT Form C non-latching relays @ 5A, 30VDC or 240VAC resistive. To prevent chattering of the relays, a 2% hysteresis is added to the alarm set point. This means that the alarm will remain active until the oxygen reading has fallen 2% below the alarm set point (high alarm) or risen 2% above the alarm set point (low alarm) after the alarm was activated. Aside from being totally defeated in the Alarm Bypass mode, the timeout feature is useful while replacing the oxygen sensor or during calibration when the oxygen reading might well rise above the alarm set point and trigger a false alarm.

Note: When making connections the user must decide whether to configure/connect Alarm 1 and Alarm 2 in failsafe mode (Normally Open – NO – where the alarm relay de-energizes and closes in an alarm condition) or non-failsafe mode (Normally Closed – NC – where alarm relay energizes and opens in an alarm condition).

Note: Selection of the optional Range ID configuration utilizes the alarms relays contacts thereby eliminating the alarms feature.

## **Power Failure Alarm**

A dry contact rated at 30VDC @ 1A is provided as a power failure alarm that activates when power supplied to the analyzer's circuits is unacceptable. The contact is normally closed but opens when the power to the analyzer is switched off or interrupted and cannot be disabled.

## **4-20mA Signal Output**

The analyzer provides a 4-20mA full scale fully isolated ground signals for external recording devices. The integral IC on the main PCB provides 4-20mA fully isolated signals for output and range ID. The 4-20mA current output is obtained by connecting the current measuring device between the positive and negative terminals labeled OUTPUT 4-20mA. To check the signal output of the 4-20mA E/I integrated circuit connect an ammeter as the measuring device and confirm the output is within  $\pm 0.1$ mA of 4mA. A finer adjustment of the zero offset of the 4-20mA converter can be provided by a potentiometer mounted on the main PCB Assembly. Consult factory for instructions

## **Range ID**

For range ID the output of 4mA, 8mA, 12mA, 16mA, 20mA correspond to the most sensitive to least sensitive analysis range.

The standard 4-20mA output used for range identification, as described below, can be replaced by eliminating the alarms feature and using the relay contacts associated with the alarms to provide a single common and four (4) normally open relay contacts that close when the related range is active. The dry contacts are rated at 30VDC @ 1A and powering them is optional as some PLCs can distinguish contact closure via continuity check.

**Caution:** The integral 4-20mA converters are internally powered and do not require external power. DO NOT supply any voltage to any of the two terminals of the 4-20mA converter.

## Installing the Oxygen Sensor

The GPR-1900MS Oxygen Analyzer is equipped with an external oxygen sensor that has been tested and calibrated by the manufacturer prior to shipment and is fully operational from the shipping containers. The sensor has not been installed at the factory and it will be necessary to install the sensor in the field. **Caution:** Review procedure before proceeding, mainly 2 and 9.

**Caution:** DO NOT open the oxygen sensor. The sensor contains a corrosive liquid electrolyte that could be harmful if touched or ingested, refer to the Material Safety Data Sheet contained in the Owner's Manual appendix. Avoid contact with any liquid or crystal type powder in or around the sensor or sensor housing, as either could be a form of electrolyte. Leaking sensors should be disposed of in manner similar to that of a common battery in accordance with local regulations.



### Procedure:

1. The sensor has not been installed at the factory (in standard configuration there are no valves to isolate the sensor) and it will be necessary to install the sensor in the field.
2. As described above the following steps should already be completed:
  - a) Secure the sensor housing bracket with two 6/32 mounting screws, in the preferred position the upper section with the interconnection cable should be facing the ceiling;
  - b) connect the gas lines;
  - c) electrical connections.
1. **Caution:** Do not change the factory settings until instructed to do in this manual.
2. Purge the oxygen trapped in the newly connected gas lines for 3-5 minutes.
3. Flow zero gas or sample gas with a low ppm oxygen concentration to the analyzer at the predetermined flow rate of 1 SCFH.
4. Using the 5/16 wrench supplied loosen but do not remove the clamp bolt located under the sensor housing, see photo.
5. Rotate the upper section of the sensor housing 90° to disengage from the clamp.
6. Remove the upper section by pulling it straight up and place it on a smooth surface.
7. Select the AUTO RANGING option from the SAMPLE menu with gas flowing to the analyzer.
8. Remove the oxygen sensor from the bag and remove the red shorting device (including the gold ribbon) from the PCB located at the rear of the sensor.
9. Minimize the time the sensor is exposed to ambient air.
10. Immediately place the sensor in the bottom section of the sensor housing with the PCB facing up.
11. Immediately place the upper section of the sensor housing over the sensor, gently push the upper section downward and rotate 90° to engage the clamp.
12. Finger tighten the clamp bolt and then tighten it one full turn with the 5/16 wrench to securely lock the two sections of the sensor housing.
13. The analyzer will OVER RANGE for a short period of time as indicated by the graphical LCD display.
14. Wait until the display shows a meaningful oxygen reading and begins to approach the expected oxygen content of the sample gas.



## Span Gas Preparation

The GPR-1900MS must be calibrated with a certified span gas with an oxygen value below 1000 ppm. See the Accuracy & Calibration section above for recommendations. Exposure to ambient air beyond the time it takes to install the sensor can delay the calibration process and if long enough damage the sensor.

**Caution:** Do not contaminate the span gas cylinder when connecting the regulator. Bleed the air filled regulator (faster and more reliable than simply flowing the span gas) before attempting the initial calibration of the instrument.

### Required components:

- Certified span gas cylinder with an oxygen concentration, balance nitrogen, approximating 80% of the full scale range above the intended measuring range.
- Regulator to reduce pressure to 30 psig.
- Flow meter to set the flow between 1 SCFH,
- Suitable fittings and 1/8" dia. 4-6 ft. in length of metal tubing to connect the regulator to the flow meter inlet

- Suitable fitting and 1/8" dia. 4-6 ft. in length of metal tubing to connect from the flow meter vent to tube fitting designated SAMPLE IN on the GPR-1900MS.

## Procedure:

1. With the span gas cylinder valve closed, install the regulator on the cylinder.
2. Open the regulator's exit valve and partially open the pressure regulator's control knob.
3. Open slightly the cylinder valve.
4. Loosen the nut connecting the regulator to the cylinder and bleed the pressure regulator.
5. Retighten the nut connecting the regulator to the cylinder
6. Adjust the regulator exit valve and slowly bleed the pressure regulator.
7. Open the cylinder valve completely.
8. Set the pressure between 5-30 psig using the pressure regulator's control knob.
9. **Caution:** Do not exceed the recommended flow rate. Excessive flow rate could cause the backpressure on the sensor and may result in erroneous readings and permanent damage to the sensor.

## Establishing Power to the Electronics:

Once the power to the electronics is established, the digital display responds instantaneously. When power is applied, the analyzer performs several diagnostic system status checks termed "START-UP TEST" as illustrated below:

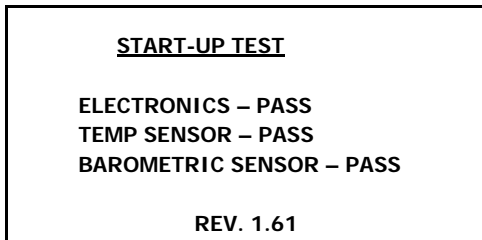

**Note:** The analyzer display defaults to the sampling mode when 30 seconds elapses without user interface.

**Note:** At installation expect the range to default to 25% range, thereafter, 100 ppm range but only if properly isolated.

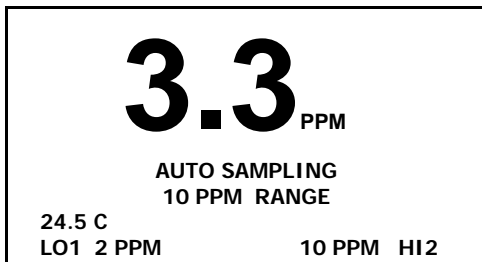

## Menu Navigation

The four (4) pushbuttons located on the front of the analyzer operate the micro-processor:

1. blue ENTER (select)
2. yellow UP ARROW
3. yellow DOWN ARROW
4. green MENU (escape)



## Main Menu

Access the MAIN MENU by pressing the MENU key:

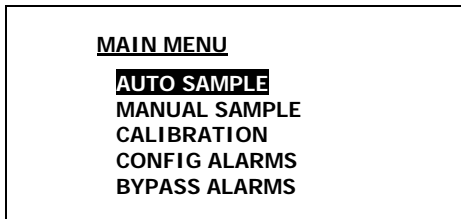

## Range Selection

The GPR-1900MS analyzer is equipped with four (4) standard measuring ranges (see specification) and provides users with a choice of sampling modes. By accessing the MAIN MENU, users may select either the AUTO SAMPLING (ranging) or MANUAL SAMPLING (to lock on a single range) mode.

**Note:** For calibration purposes, use of the AUTO SAMPLE mode is recommended. However, the user can select the full scale MANUAL SAMPLE RANGE for calibration as dictated by the accuracy of the analysis required – for optimal accuracy, a span gas with an 800 ppm oxygen concentration with the balance nitrogen would dictate the use of the 0-1000 ppm full scale range for calibration for analysis below 100 ppm, whereas, 80 ppm span gas is acceptable but not “optimal”, see Calibration & Accuracy.

### Auto Sampling:

1. Access the MAIN MENU by pressing the MENU key.
2. Advance the reverse shade cursor using the ARROW keys to highlight AUTO SAMPLE.
3. Press the ENTER key to select the highlighted menu option.
4. The display returns to the sampling mode:

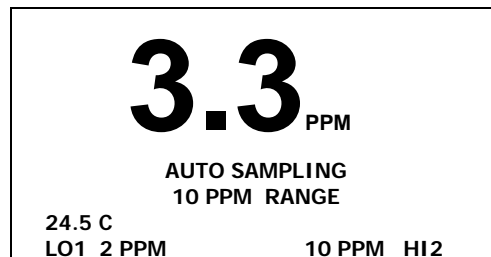
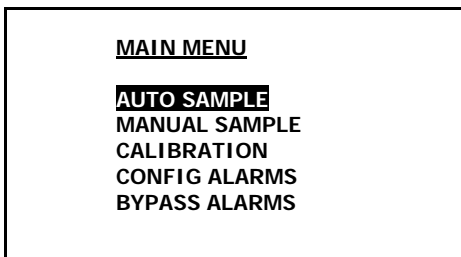

The display will shift to the next higher range when the oxygen reading (actually the sensor's signal output) exceeds 99.9% of the upper limit of the current range. The display will shift to the next lower range when the oxygen reading drops to 85% of the upper limit of the next lower range.

For example, if the analyzer is reading 1% on the 0-10% range and an upset occurs, the display will shift to the 0-25% range when the oxygen reading exceeds 9.9%. Conversely, once the upset condition is corrected, the display will shift back to the 0-10% range when the oxygen reading drops to 8.5%.

### Manual Sampling:

1. Access the MAIN MENU by pressing the MENU key.
2. Advance the reverse shade cursor using the ARROW keys to highlight MANUAL SAMPLE.
3. Press the ENTER key to select the highlighted menu option.
4. The following display appears:



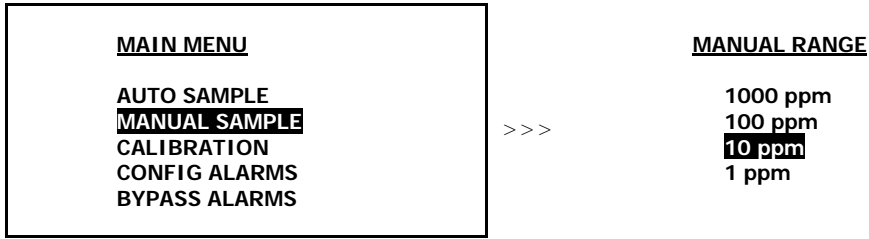

5. Advance the reverse shade cursor using the ARROW keys to highlight the desired MANUAL RANGE.
6. Press the ENTER key to select the highlighted menu option.
7. The following displays appears with the range selected and oxygen concentration of the sample gas:

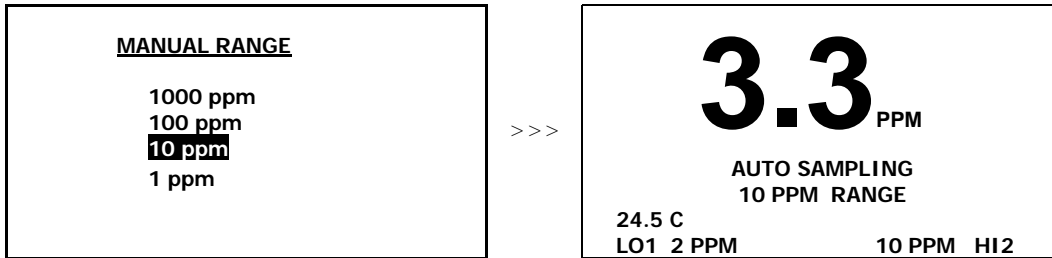

8. The display will not shift automatically. Instead, when the oxygen reading (actually the sensor's signal output) exceeds 110% of the upper limit of the current range an OVER RANGE warning will be displayed.
9. Once the OVER RANGE warning appears the user must advance the analyzer to the next higher range via the menu and keypad Press MENU, select MANUAL SAMPLING, press ENTER, select the appropriate MANUAL RANGE and press ENTER again.

## Alarms

The CONFIG ALARMS features a system that can be configured in the field. Two field adjustable alarm relays with dry contacts operate independently of one another which means the alarms can be set-up as:

- HI and LO
- LO and LO, LO,
- HI and HI,HI

Additional feature includes delaying the activation of the local audible alarm and relay contacts for up 99 minutes to enable users to distinguish between transient occurrences and true upset conditions which is particularly useful on remote applications without affecting the 4-20mA signal output. The local audible alarm can be silenced or disabled as well without affecting the 4-20mA signal output.

**Note:** A separate feature, BYPASS ALARMS described below, enables the user to disable the local audible alarm and relay contacts during calibration or servicing. The alarms are enabled when the alarm condition is corrected.

**Note:** If the "Range ID with Relay Contacts" option is specified, the alarm feature is eliminated.

### Set Alarm Values:

1. Access the MAIN MENU by pressing the MENU key.
2. Advance the reverse shade cursor using the ARROW keys to highlight CONFIG ALARMS.
3. Press the ENTER key to select the highlighted menu option.
4. The following displays appears:

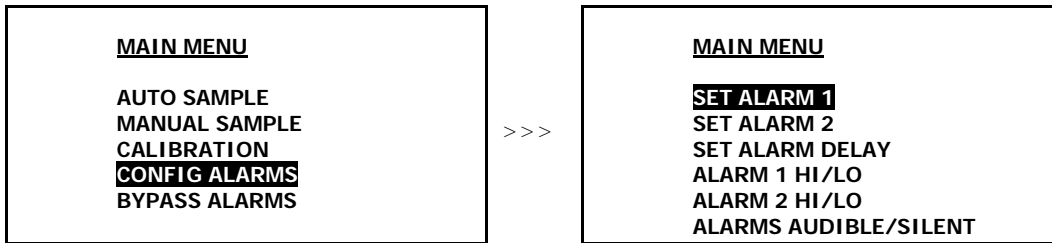

5. Advance the reverse shade cursor using the ARROW keys to highlight the SET ALARM 1 option.
6. Press the ENTER key to select the highlighted menu option.
7. The following displays appears with PERCENT as the default alarm value :

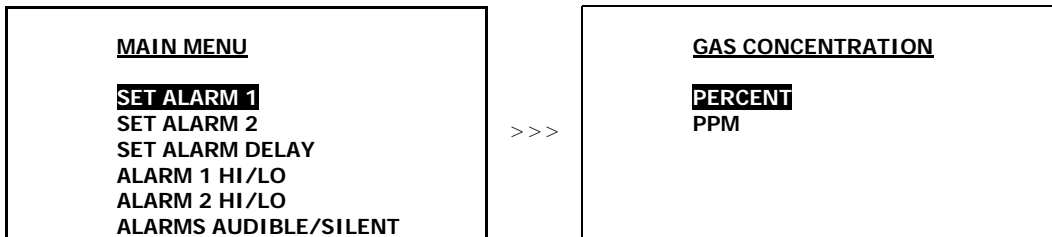

8. Advance the reverse shade cursor using the ARROW keys to highlight the desired option.
9. Press the ENTER key to select the highlighted menu option.
10. **Note:** The PERCENT alarm value is entered with one decimal, the PPM alarm value is entered as an integer.

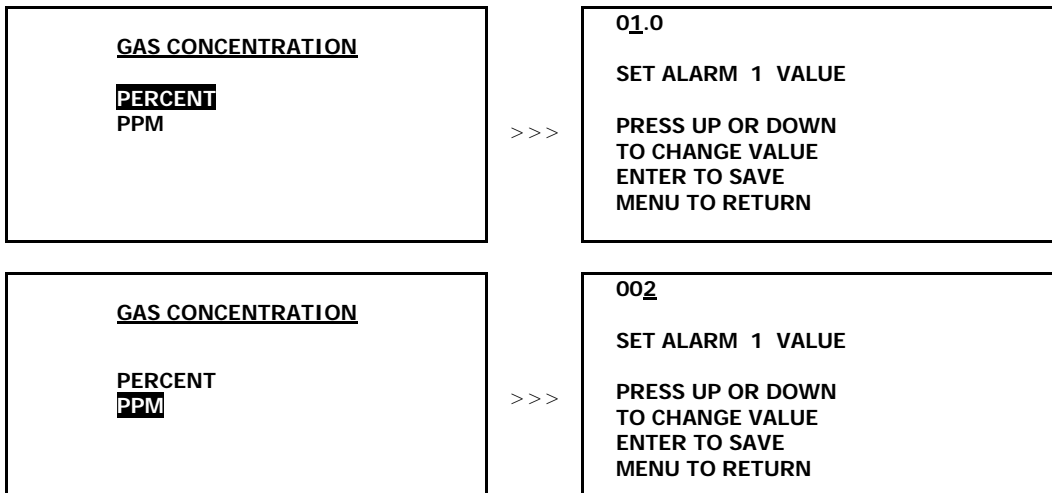

11. Press the ENTER key to advance the underline cursor right or press the MENU key to advance the underline cursor left to reach to the desired digit of the alarm value.
12. Press the ARROW keys to enter the alarm value.
13. Repeat steps 11 and 12 until the complete span value has been entered.
14. **Note:** If an alarm is set as a PERCENT value and subsequently changed to a PPM value, the PERCENT value is not retained and is reset to 00.0. This holds if the alarm was first set as PPM value and then changed to a PERCENT value.
15. **Save the alarm value by pressing the ENTER key or abort by pressing the MENU key.**
16. The system returns to the SAMPLING mode and displays:

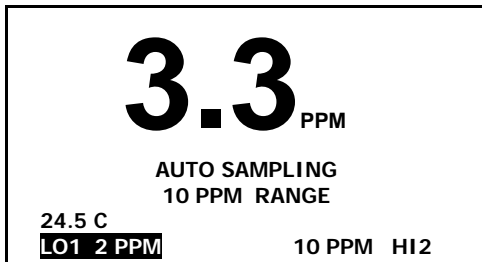

Repeat the steps above to set the ALARM 2 value:

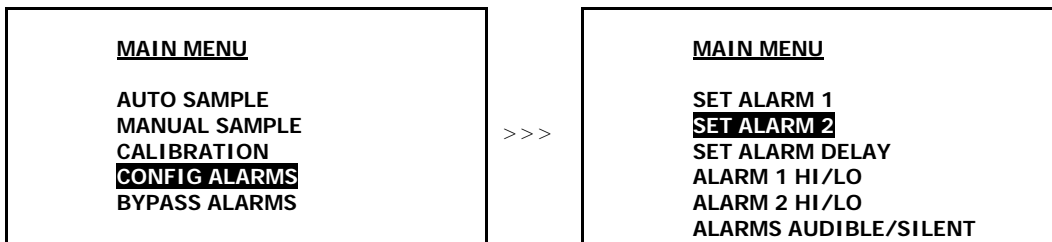

**Set Alarm Delay:**

Once the values for ALARM 1 and ALARM 2 have been entered, the user may elect to delay the activation of the local alarms and relay contacts for up to 99 minutes. This feature allows users to distinguish between transient occurrences and true upset conditions. This feature can be particularly useful on remote applications without affecting the 4-20mA signal output.

1. Access the MAIN MENU by pressing the MENU key.
2. Advance the reverse shade cursor using the ARROW keys to highlight CONFIG ALARMS.
3. Press the ENTER key to select the highlighted menu option.
4. The following displays appear:

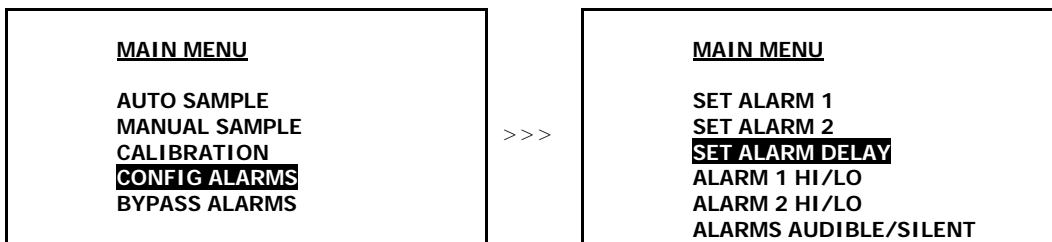

5. Advance the reverse shade cursor using the ARROW keys to highlight the SET ALARM DELAY.
6. Press the ENTER key to select the highlighted menu option.
7. The following displays appear with last alarm delay value :

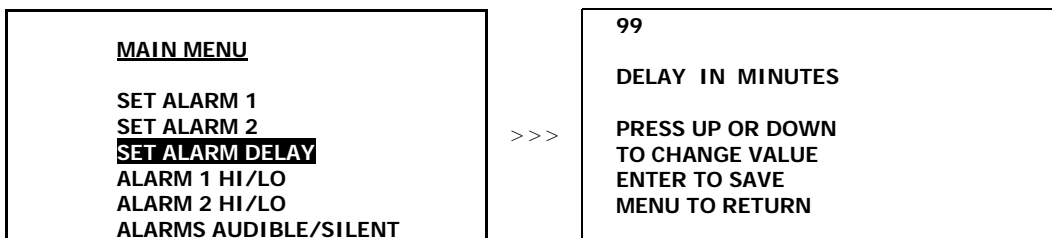

8. Press the ENTER key to advance the underline cursor right or press the MENU key to advance the underline cursor left to reach to the desired digit of the alarm value.
9. Press the ARROW keys to enter the alarm value.
10. Repeat steps 17 and 18 until the complete span value has been entered.
11. **Save the alarm value by pressing the ENTER key or abort by pressing the MENU key.**

12. The system returns the SAMPLING mode and displays:

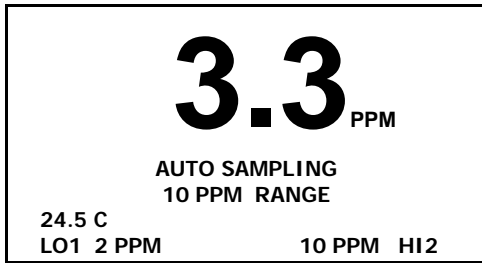

### Set HI/LO Alarms:

1. Access the MAIN MENU by pressing the MENU key.
2. Advance the reverse shade cursor using the ARROW keys to highlight CONFIG ALARMS.
3. Press the ENTER key to select the highlighted menu option.
4. The following displays appears:

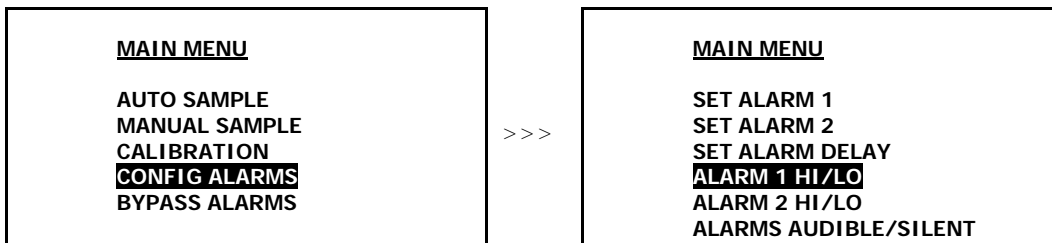

5. Advance the reverse shade cursor using the ARROW keys to highlight the ALARM 1 option, which appears as either ALARM 1 HI or ALARM 1 LO.
6. Press the ENTER key to toggle and change the displayed setting. After 3 seconds, the system returns to SAMPLING mode.

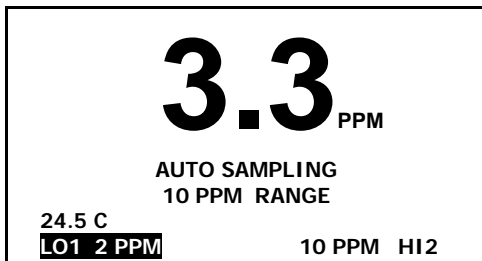

7. Repeat steps 1 through 6 for the ALARM 2 HI/LO setting.

### Set Local Alarms:

1. Access the MAIN MENU by pressing the MENU key.
2. Advance the reverse shade cursor using the ARROW keys to highlight CONFIG ALARMS.
3. Press the ENTER key to select the highlighted menu option.
4. The following displays appears:

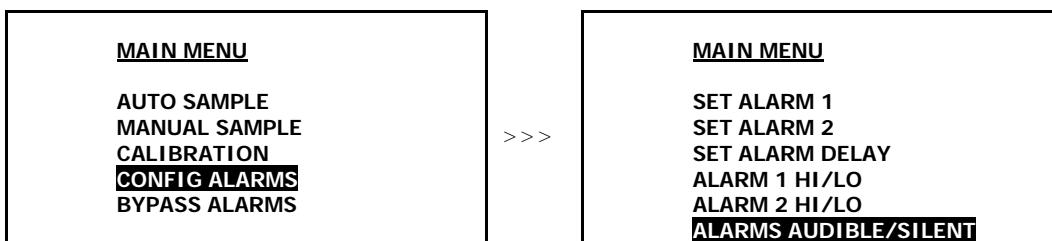

5. Advance the reverse shade cursor using the ARROW keys to highlight the ALARMS AUDIBLE/SILENT option, which appear as either ALARMS AUDIBLE or ALARMS SILENT.
6. Press the ENTER key to toggle and change the displayed setting. After 3 seconds, the system returns to SAMPLING mode.

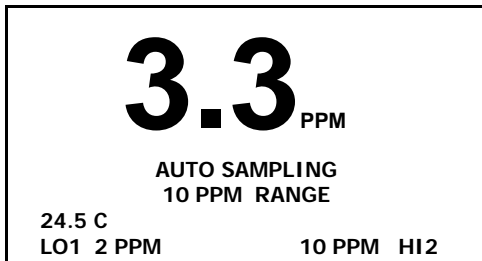

### Bypass Alarms:

This feature, separate from CONFIG ALARMS above, enables the user to disable the local audible alarm and relay contacts during calibration or servicing. The alarms are enabled when the alarm condition is corrected.

1. Access the MAIN MENU by pressing the MENU key.
2. Advance the reverse shade cursor using the ARROW keys to highlight BYPASS ALARMS.
3. The following displays appears:

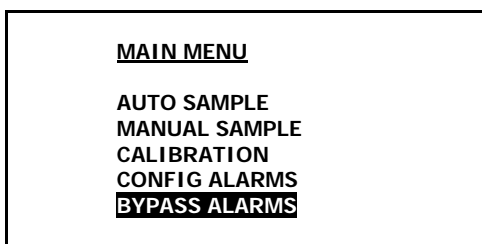

4. Press the ENTER key to bypass and disable both the local audible alarm and relay contacts. After 3 seconds, the system returns to SAMPLING mode.

**Note:** The appropriate alarm setting will alternately reverse shades indicating the alarm condition exists but the BYPASS ALARMS feature has disabled the local audible alarm and relay contact. The alarms are enabled when the alarm condition is corrected.

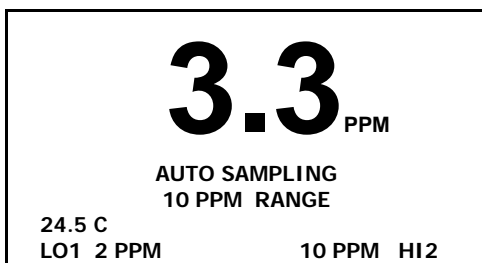

Installation & Start-up is now complete . . . proceed to Calibration

## Zero Calibration

In theory, the galvanic fuel cell type oxygen has an absolute zero meaning it produces no signal output when exposed to an oxygen free sample gas. In reality, expect the analyzer to generate an oxygen reading when sampling a zero gas due to:

- Contamination or quality of the zero gas
- Minor leakage in the sample line connections
- Residual oxygen dissolved in the sensor's electrolyte
- Tolerances of the electronic components

The Zero Offset capability of the analyzer is limited to 50% of lowest most sensitive range available with the analyzer.

As part of our Quality Control Certification process, the zero capability of every ppm analyzer is qualified prior to shipment. However, because the factory sample system conditions differ from that of the user, no ZERO OFFSET adjustment is made to analyzer by the factory

### Recommendations:

- Zero calibration is recommended only for online analyzers performing continuous analysis below 5% of the lowest most sensitive range available with a ppm analyzer, e.g. analysis below 0.05 ppm on the 0-1 ppm range, 0.5 ppm on the 10 ppm range, or below 0.1% (1000 ppm) with a percent analyzer.
- Determining the true Zero Offset requires approximately 24 hours to assure the galvanic fuel cell sensor has consumed the oxygen that has dissolved into the electrolyte inside the sensor while exposed to air or percentage levels of oxygen. Allow the analyzer to stabilize with flowing zero gas as evidenced by a stable reading or horizontal trend on an external recording device. For optimum accuracy, utilize as much of the actual sample system as possible.
- Zero calibration is not practical and not recommended for portable analyzers or measurements on higher ranges. However, satisfying these users that the zero offset is acceptable for their application without the 24 hour wait can be accomplished by introducing a zero gas (or sample gas with a low ppm oxygen concentration) to the analyzer. Unless the zero gas is contaminated or there is a significant leak in the sample connections, the analyzer should read less than 100 ppm oxygen within 10 minutes after being placed on zero gas thereby indicating it is operating normally.
- Zero calibration should precede span calibration.
- Initiate the DEFAULT ZERO and DEFAULT SPAN procedures before performing either a ZERO or SPAN CALIBRATION.
- **Caution:** Prematurely initiating the ZERO CALIBRATION function can result in negative readings near zero.
- Once the zero offset adjustment is made, zero calibration is normally not required again until the sample system connections are modified, or, when installing a new oxygen sensor.

### Procedure:

Zero calibration should precede the span calibration and once performed should not have to be repeated with subsequent span calibrations. Normally, zero calibrations are performed when a new sensor is installed or changes are made in the sample system connections.

Refer to Span Calibration below for the detailed procedure. Differences include the displays illustrated below, substituting a suitable zero gas for the span gas and the time required to determine the true zero offset of specific oxygen sensor, analyzer and sample system combination.

The maximum zero calibration adjustment permitted is 50% of the lowest full scale range available. Accordingly, the analyzer's ZERO has not been adjusted prior to shipment because the factory conditions are different from the application condition at the user's installation.

1. Access the MAIN MENU by pressing the MENU key.
2. Advance the reverse shade cursor using the ARROW keys to highlight CALIBRATION.
3. Press the ENTER key to select the highlighted menu option.
4. The following displays appear:

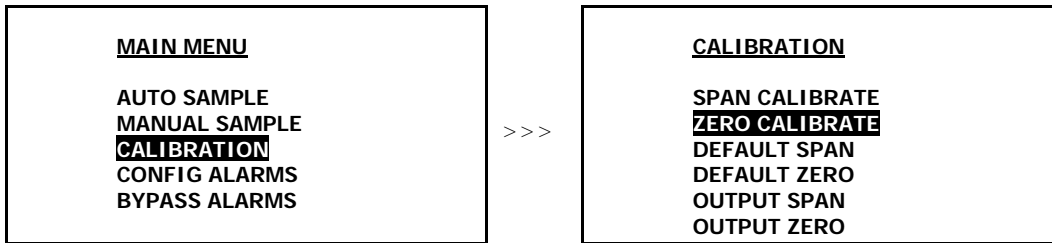

5. Advance the reverse shade cursor using the ARROW keys to highlight ZERO CALIBRATE.
6. Press the ENTER key to select the highlighted menu option.
7. The following displays appear:

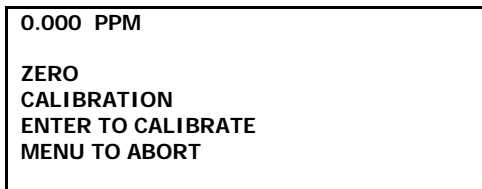

8. Press the ENTER key to calibrate or MENU key to abort and return to SAMPLING mode.
9. Allow approximately 60 seconds for the calibration process while the processor determines whether the signal output or reading has stabilized within 50% of the full scale low range.
10. Both the Zero Calibrate and Span Calibrate functions result in the following displays:

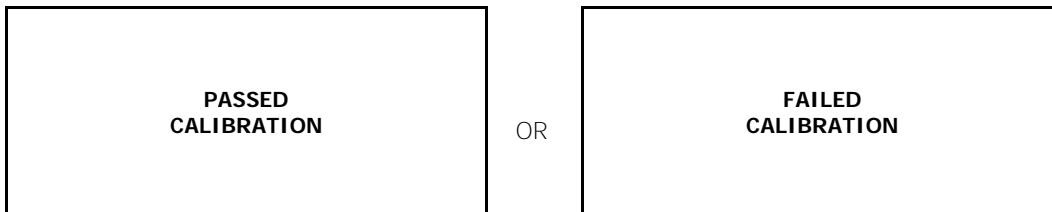

### Default Zero:

The software will eliminate any previous zero calibration adjustment and display the actual the signal output of the sensor at any specific oxygen concentration. For example, assuming a zero gas is introduced, the display will reflect an oxygen reading representing basically the zero calibration adjustment as described above. This feature allows the user to test the sensor's signal output without removing it from the sensor housing.

### Procedure:

1. Access the MAIN MENU by pressing the MENU key.
2. Advance the reverse shade cursor using the ARROW keys to highlight CALIBRATION.
3. Press the ENTER key to select the highlighted menu option.
4. The following displays appear:

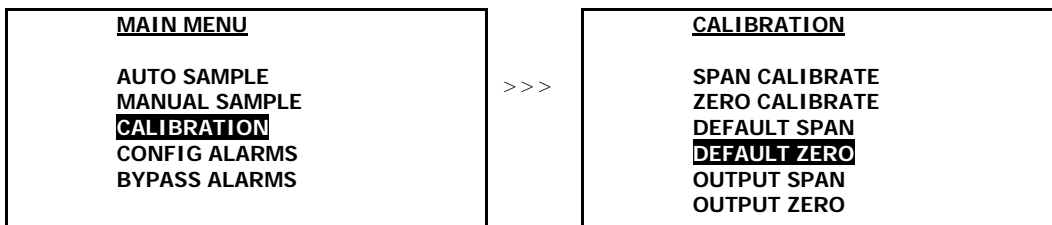

5. Advance the reverse shade cursor using the ARROW keys to highlight DEFAULT ZERO.
6. Press the ENTER key to select the highlighted menu option.
7. The following display appears and after 3 seconds the system returns to the SAMPLING mode:

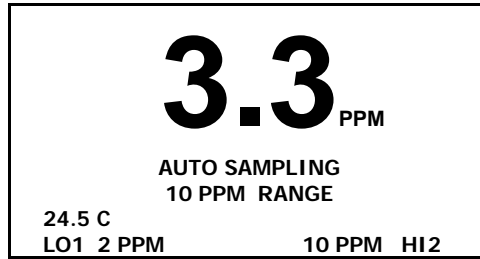
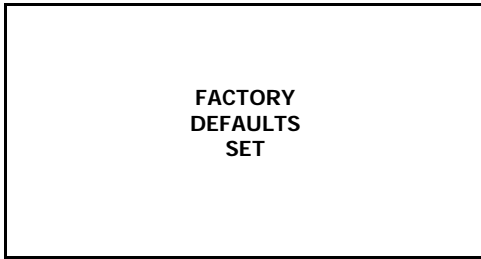

### Output Zero:

In rare instances the 4-20mA signal output may not agree to the reading displayed by the LCD. This feature enables the user to adjust the 4mA signal output when the LCD displays 00.00. Compute the adjustment value as described in Appendix B or consult the factory.

**Note:** Adjust the 20mA signal output with the OUTPUT SPAN option described below. The true adjustment value must be determined empirically by trial and error. Adjust the initial adjustment value for additional percent errors.

### Procedure:

1. Access the MAIN MENU by pressing the MENU key.
2. Advance the reverse shade cursor using the ARROW keys to highlight CALIBRATION.
3. Press the ENTER key to select the highlighted menu option.
4. The following displays appear:

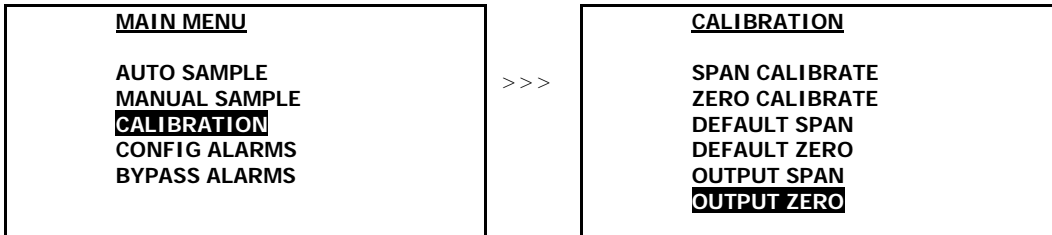

5. Advance the reverse shade cursor using the ARROW keys to highlight OUTPUT ZERO.
6. Press the ENTER key to select the highlighted menu option.
7. The following display appears

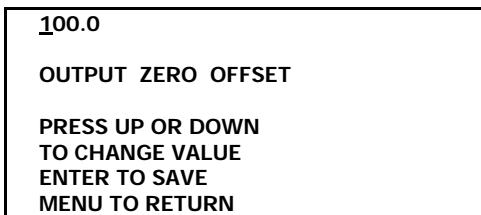

8. Compute the adjustment value as described in Appendix B. **Note:** The true adjustment value must be determined empirically by trial and error. Adjust the initial adjustment value for additional percent errors.

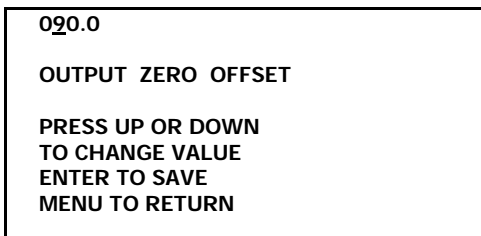



9. Press the ENTER key to advance the underline cursor right or press the MENU key to advance the underline cursor left to reach to the desired digit of the OUTPUT ZERO OFFSET value.
10. Press the ARROW keys to enter the OUTPUT ZERO OFFSET value.
11. Repeat steps 9 and 10 until the complete OUTPUT ZERO OFFSET value has been entered.
12. **Save the adjustment value by pressing the ENTER key or abort by pressing the MENU key.**
13. The system returns to the SAMPLING mode.

## Span Calibration

Span Calibration involves adjusting the transmitter electronics to the sensor's signal output at a given oxygen standard. Maximum drift from calibration temperature is approximately 0.11% of reading per °C. The frequency of calibration varies with the application conditions, the degree of accuracy required by the application and the quality requirements of the user. However, the interval between span calibrations should not exceed three (3) months.

**Note:** Regardless of the oxygen concentration of the standard used, the span calibration process takes approximately 10 minutes, however, the time required to bring the analyzer back on-line can vary depending on a combination of factors and assume exposure to a zero/purge/sample gas\*\* with an oxygen content below the stated thresholds immediately after span calibration:

Galvanic Sensor *	Oxygen Standard	Time Required to Come On-line**
O <sub>2</sub> levels above 1000 ppm / 0.1%	Air (209,000 ppm / 20.9%)	< 5 minutes
O <sub>2</sub> levels above 100 ppm	Air (209,000 ppm / 20.9%)	< 10 minutes
O <sub>2</sub> levels below 10 ppm	Air (209,000 ppm / 20.9%)	< 60 minutes for install or replacement < 30 minutes if in ppm service for > 1 week
O <sub>2</sub> levels below 10 ppm	800 ppm Certified Span Gas	< 5 minutes
O <sub>2</sub> levels below 10 ppm	80 ppm Certified Span Gas	< 1 minute

\* Refer to analyzer specifications for comparable data on the Pico-Ion UHP and MS oxygen sensors.

### Recommendations General:

- The interval between span calibrations should not exceed three (3) months.
- Initiate the DEFAULT ZERO and DEFAULT SPAN procedures before performing either a ZERO or SPAN CALIBRATION.
- **Caution:** Prematurely initiating the SPAN CALIBRATION function before the analyzer reading has stabilized can result in erroneous readings. This is especially true when installing a new sensor that must adjust to the difference in oxygen concentrations. It should take about 2 minutes for the sensor to equilibrate in ambient air from storage packaging.
- Always calibrate at the same temperature and pressure of the sample gas stream.
- For 'optimum calibration accuracy' calibrate with a span gas approximating 80% of the full scale range or a higher range than the full scale range of interest (normal use) to achieve the effect of "narrowing the error" by moving downscale as illustrated by Graph A in the Accuracy & Calibration section.
- Calibrating with a span gas approximating 5-10% of the full scale range near the expected oxygen concentration of the sample gas is acceptable but less accurate than 'optimum calibration accuracy' method recommended – the method usually depends on the gas available.
- Calibrating at the same 5-10% of the full scale range for measurements at the higher end of the range (example: calibrating an Oxygen Purity Analyzer in air at 20.9% oxygen with the intention of measuring oxygen levels of 50-100%) results in the effect of "expanding the error" by moving upscale as illustrated by Graph A and Example 1 in the Accuracy & Calibration section above and is not recommended. Of course the user can always elect at his discretion to accept an accuracy error of ±2-3% of full scale range if no other span gas is available.

### Recommendations Air Calibration:

- Do not calibrate an analyzer employing the Pico-Ion UHP or MS sensor, or, an oxygen purity sensor with air.

- The inherent linearity of the galvanic fuel cell type oxygen sensor enables the user to calibrate any analyzer (except those using UHP or MS Pico-Ion sensors or intended for oxygen purity analysis) with ambient air (20.9% oxygen) and operate the analyzer within the stated accuracy spec on the lowest most sensitive range available with the analyzer – it is not necessary to recalibrate the analyzer with span gas containing a lower oxygen concentration.
- When installing or replacing a ppm or percent oxygen sensor.
- To verify the oxygen content of a certified span gas.
- When certified span gas is not available to calibrate a ppm analyzer (immediately following air calibration reintroduce a gas with a low oxygen concentration to expedite the return to ppm level measurements as described above \*\*).

**Required components: Refer to Installing Span Gas section above.**

1. Certified span gas cylinder with an oxygen concentration, balance nitrogen, approximating 80% of the full scale range above the intended measuring range.
2. Regulator to reduce pressure to between 5 and 30 psig.
3. Flow meter to set the flow between 1-5 SCFH,
4. Suitable fittings and a 4-6 ft. in length of 1/8" dia. metal tubing to connect the regulator to the flow meter inlet
5. Suitable fitting and a 4-6 ft. in length of 1/8" dia. metal tubing to connect to the flow meter vent
6. 1/8" male NPT to tube adapter fitting to connect the 1/8" dia. metal tubing from the flow meter vent to the mating male fitting supplied with the GPR-1900MS.

**Procedure:**

The user must ascertain that the oxygen reading (actually the sensor's signal output) has reached a stable value within the limits entered below before entering the span adjustment. Failure to do so will result in an error.

This procedure assumes a span gas under positive pressure and is recommended for a analyzer without an optional sampling pump, which if installed downstream of the sensor should be placed in the OFF position and disconnected so the vent is not restricted during calibration. To assure an accurate calibration, the temperature and pressure of the span gas must closely approximate the sample conditions.

For calibration purposes, use of the AUTO SAMPLE mode is recommended. However, the user can select the full scale MANUAL SAMPLE RANGE for calibration as dictated by the accuracy of the analysis required – for example, a span gas with an 80 ppm oxygen concentration with the balance nitrogen would dictate the use of the 0-100 ppm full scale range for calibration and a 0-10 ppm measuring range. Select as described above.

1. Access the MAIN MENU by pressing the MENU key.
2. Advance the reverse shade cursor using the ARROW keys to highlight AUTO SAMPLE.
3. Press the ENTER key to select the highlighted menu option.
4. The following displays appear:

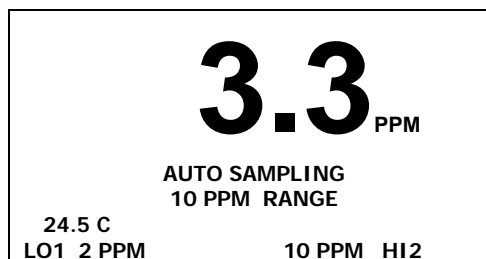
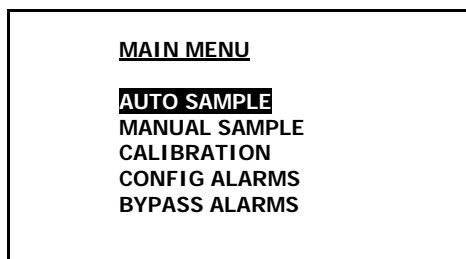

5. Return to the MAIN MENU by pressing the MENU key.
6. Advance the reverse shade cursor using the ARROW keys to highlight CALIBRATION.
7. Press the ENTER key to select the highlighted menu option.
8. Repeat to select SPAN CALIBRATE
9. The following displays appear:

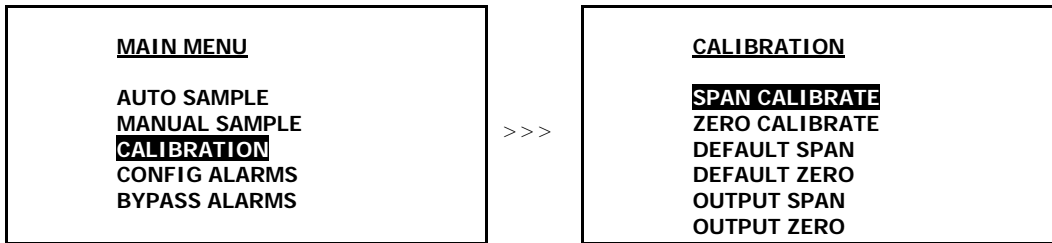

- Assure there are no restrictions in vent line.
- Regulate the pressure and control the flow rate as described above at 5-30 psig and a 2 SCFH flow rate.
- Allow the span gas to flow for 1-2 minutes to purge the air trapped in the span gas line.
- Disconnect the sample gas line and install the purged span gas line.
- Caution: Allow the span gas to flow and wait until the reading is stable before proceeding with calibration.**  
The wait time will vary depending on the amount oxygen introduced to the sensor when the gas lines were switched.
- Press the ENTER key to select the SPAN CALIBRATE option.
- Note:** A span gas concentration above 1000 ppm dictates the selection of the PERCENT option.
- Advance the reverse shade cursor using the ARROW keys to highlight the desired GAS CONCENTRATION.
- Press the ENTER key to select the highlighted menu option.

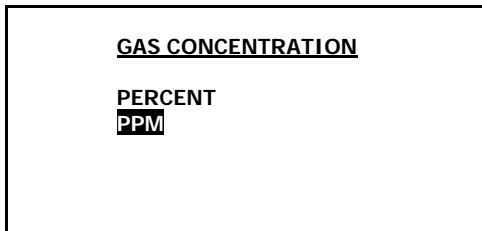

- The following displays appear:

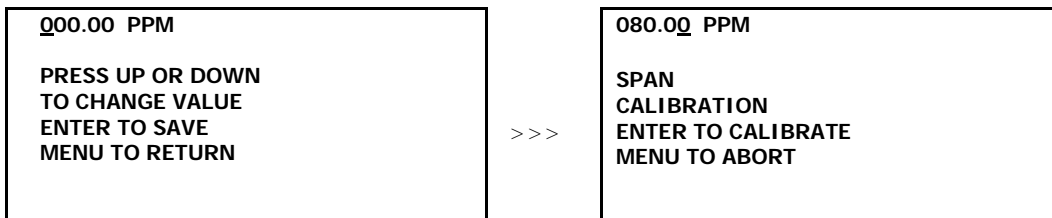

- Press the ENTER key to advance the underline cursor right or press the MENU key to advance the underline cursor left to reach to the desired digit of the alarm value.
- Press the ARROW keys to enter the alarm value.
- Repeat steps 20 and 21 until the complete SPAN value has been entered.
- Save the adjustment value by pressing the ENTER key or abort by pressing the MENU key.**
- Allow approximately 60 seconds for the calibration process while the processor determines whether the signal output or reading has stabilized within 60% of the full scale low range. Both the Zero Calibrate and Span Calibrate functions result in the following displays:

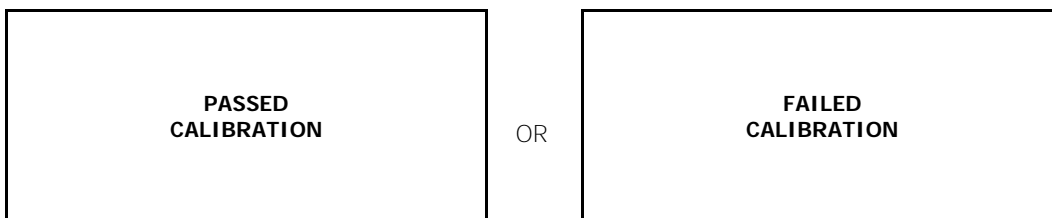

- If the calibration is successful, the analyzer returns to the SAMPLING mode after 30 seconds.

26. If the calibration is unsuccessful, return to the SAMPLING mode with span gas flowing through the analyzer, make sure the reading stabilizes and repeat the calibration before concluding the equipment is defective.
27. Before disconnecting the span gas line and connecting the sample gas line, restart if necessary the flow of sample gas and allow it to flow for 1-2 minutes to purge the air inside the line.
28. For ppm sensors disconnect the span gas line and replace it with a purged, see above, zero or low oxygen content gas line to purge the sensor down to the desired analysis range as quickly as possible.
29. Wait until the reading is stable and proceed to sampling.

## Default Span

The software will set the SPAN adjustment based on the average oxygen reading (actually the sensor's signal output) at any specific oxygen concentration. For example, when a span gas is introduced, the micro-processor will display an oxygen reading within  $\pm 50\%$  of the span gas value. This feature allows the user to test the sensor's signal output without removing it from the sensor housing.

## Procedure:

1. Access the MAIN MENU by pressing the MENU key.
2. Advance the reverse shade cursor using the ARROW keys to highlight CALIBRATION.
3. Press the ENTER key to select the highlighted menu option.
4. The following displays appears:

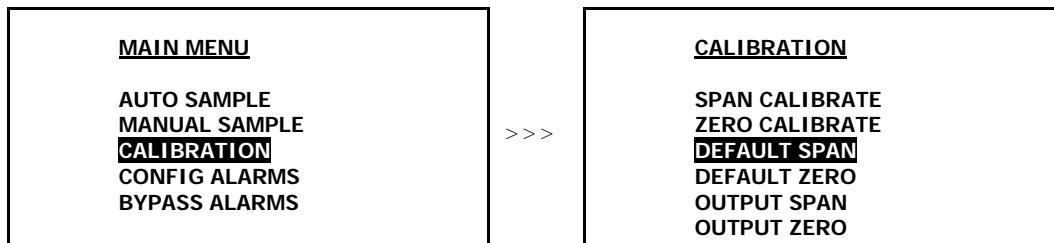

5. Advance the reverse shade cursor using the ARROW keys to highlight DEFAULT SPAN.
6. Press the ENTER key to select the highlighted menu option.
7. The following displays appear and after 3 seconds the system returns to the SAMPLING mode:

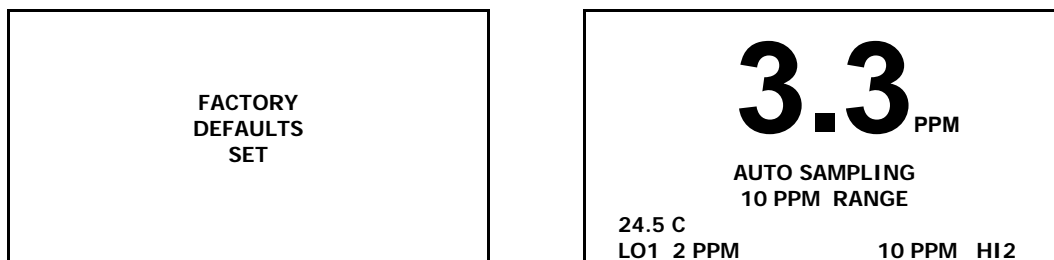

## Output Span:

In rare instances the 4-20mA signal output may not agree to the reading displayed by the LCD. This feature enables the user to adjust the 20mA signal output should the LCD display not agree.

**Note:** Adjust the 4mA signal output with the OUTPUT ZERO option described above.

## Procedure:

1. Access the MAIN MENU by pressing the MENU key.
2. Advance the reverse shade cursor using the ARROW keys to highlight CALIBRATION.
3. Press the ENTER key to select the highlighted menu option.
4. The following displays appear:

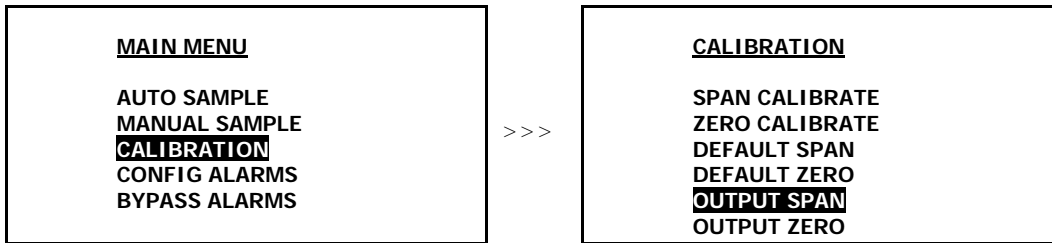

5. Advance the reverse shade cursor using the ARROW keys to highlight OUTPUT SPAN.
6. Press the ENTER key to select the highlighted menu option.
7. The following display appears

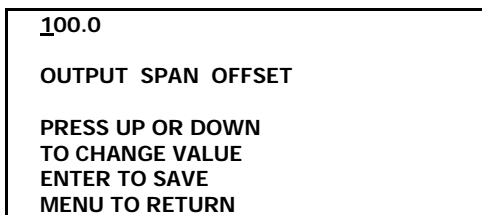

8. Compute the adjustment value as described in Appendix B or consult the factory. The true adjustment value must be determined empirically by trial and error. Adjust the initial adjustment value for additional percent errors.

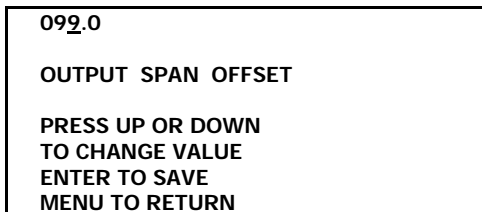

9. Press the ENTER key to advance the underline cursor right or press the MENU key to advance the underline cursor left to reach to the desired digit of the OUTPUT SPAN OFFSET value.
10. Press the ARROW keys to enter the OUTPUT SPAN OFFSET value.
11. Repeat steps 9 and 10 until the complete OUTPUT SPAN OFFSET value has been entered.
12. **Save the adjustment value by pressing the ENTER key or abort by pressing the MENU key.**
13. The system returns to the SAMPLING mode.

## Sampling

GPR-1900MS Oxygen Analyzer requires positive pressure to flow the sample gas by the sensor to measure the oxygen concentration in a sample gas. See Sample System and Pressure & Flow at the beginning of Section 5 Operations. To assure optimal performance: connect gas lines with metal tubing, quality compression type fittings to minimize leaks, follow pressure and flow recommendations and avoid exposing the sensor to air and high oxygen concentrations for prolonged periods of time (this does not include the 5 minutes it should take to air calibrate the analyzer once a week).

**Note:** Prematurely initiating the ZERO CALIBRATION procedure can cause the analyzer to display a negative reading in both the ZERO and SAMPLE modes. Prematurely initiating the SPAN CALIBRATION procedure can cause erroneously high offsets and inaccurate readings.

### Procedure:

Following calibration the analyzer returns to the SAMPLE mode after 30 seconds.

1. Select the desired sampling mode - auto or if manual, the range that provides maximum resolution – as described above.
2. Use metal tubing to transport the sample gas to the analyzer.
3. The main consideration is to eliminate air leaks which can affect oxygen measurements above or below the 20.9% oxygen concentration in ambient air - ensure the sample gas tubing connections fit tightly into the 1/8" male NPT to tube adapter, and, the NPT end is taped and securely tightened into the mating male quick disconnect fittings which mate with the female fittings on the analyzer
4. Assure there are no restrictions in the sample line.
5. For sample gases under positive pressure the user must provide a means of controlling the inlet pressure at 30 psig and the flow of the sample gas at 1 SCFH.
6. For sample gases under atmospheric or slightly negative pressure an optional sampling pump is recommended to draw the sample into the analyzer. Generally, no pressure regulation or flow control device is involved.
7. **Caution:** If the analyzer is equipped with an optional sampling pump and is intended for use in both positive and atmospheric/slightly negative pressure applications where a flow meter valve is involved – ensure the valve is completely open when operating the sampling pump. Refer to the Pressure & Flow section above.
8. Assure the sample is adequately vented for optimum response and recovery – and safety.
9. Allow the oxygen reading to stabilize for approximately 10 minutes at each sample point.

### To avoid erroneous oxygen readings and damaging the sensor:

- Do not place your finger over the vent (it pressurizes the sensor) to test the flow indicator when gas is flowing to the sensor. Removing your finger (the restriction) generates a vacuum on the sensor and may damage the sensor (voiding the sensor warranty).
- Assure there are no restrictions in the sample or vent lines
- Avoid drawing a vacuum that exceeds 14" of water column pressure – unless done gradually
- Avoid excessive flow rates above 3 SCFH.
- Avoid sudden releases of backpressure that can severely damage the sensor.
- Avoid the collection of particulates, liquids or condensation collect on the sensor that could block the diffusion of oxygen into the sensor.
- If the analyzer is equipped with an optional integral sampling pump (positioned downstream of the sensor) and a flow control metering valve (positioned upstream of the sensor), completely open the flow control metering valve to avoid drawing a vacuum on the sensor and placing an undue burden on the pump.

## Standby

- The analyzer has no special storage requirements.
- The sensor should remain connected during storage periods.
- Store the analyzer with the power OFF.
- If storing for an extended period of time protect the analyzer, cable and sensor from dust, heat and moisture.

## 6 Maintenance

There are no moving parts in the analyzer given the modular nature of the electronics and sensor. Cleaning the electrical contacts when replacing the sensor is the extent of the maintenance requirements of this analyzer. **Serviceability:** Except for replacing the oxygen sensor, there are no parts inside the analyzer for the operator to service. Only trained personnel with the authorization of their supervisor should conduct maintenance.

### Sensor Replacement:

Periodically, the oxygen sensor will require replacement. The operating life is determined by a number of factors that are influenced by the user and therefore difficult to predict. The sections dealing with Specification and Installation Considerations define the normal operating conditions and expected life of the standard sensor utilized by the GPR-1900MS analyzer. As a general guideline, expected sensor life is inversely proportional to changes in oxygen concentration, pressure and temperature.

**Caution:** DO NOT open the oxygen sensor. The sensor contains a corrosive liquid electrolyte that could be harmful if touched or ingested, refer to the Material Safety Data Sheet contained in the Owner's Manual appendix. Avoid contact with any liquid or crystal type powder in or around the sensor or sensor housing, as either could be a form of electrolyte. Leaking sensors should be disposed of in accordance with local regulations.

### Procedure:

1. Determine your calibration requirements by reviewing the ZERO CALIBRATION and SPAN CALIBRATION discussions in section 5 Operation. Consult the analyzer specifications for recovery times and span gas values.
2. GPR-1900MS-R or -W options - turn the screw securing the analyzer's front panel marked SENSOR or open the door of the wall mount enclosures.
3. Using the 5/16 wrench supplied loosen but do not remove the clamp bolt located in the center of the bracket attached to bottom section with the elbow fittings.
4. Rotate the upper section of the sensor housing 90° to disengage from the clamp.
5. Remove the upper section by pulling it straight up and place it on a smooth surface.
6. Remove the old oxygen sensor and dispose of it as you would a battery.
7. Remove the o-ring from the bottom section of the sensor housing.
8. Wipe the o-ring with a damp lint free cloth.
9. Lightly lubricate the o-ring with vacuum grease for optimal seal.
10. Reinstall the o-ring into the bottom section of the sensor housing.
11. From the MAIN MENU select AUTO RANGING as described above.
12. If equipped with SAMPLE/BYPASS valve, place it in the SAMPLE position.
13. Set the flow rate to 1 SCFH.
14. Connect zero gas or low oxygen content sample gas line to purge the lines and the sensor of oxygen (once reinstalled).
15. **Caution:** Minimize the time the new sensor is exposed to ambient air.
16. Remove the new oxygen sensor from the shipping bag.
17. Remove the red label and the gold ribbon (shorting device) from the PCB at the rear of the sensor.
18. Place the new sensor in the bottom section of the sensor housing with the PCB facing up.
19. Place the upper section of the sensor housing over the sensor.
20. Gently push the upper section downward and rotate 90° to engage the clamp.
21. Finger tighten the clamp bolt and one full turn with the 5/16 wrench to compressed the o-ring seal.
22. Expect the analyzer reading to recover to ppb levels as described in the analyzer specification.
23. Perform the desired calibration(s).
24. Begin sampling once the analyzer has reached the value of the purge gas.



## 7 Spare Parts

Recommended spare parts for the GPR-1900MS Oxygen Analyzer include:

<b>Item No.</b>	<b>Description</b>
GPR-12-2000MS	ppm Oxygen Sensor

Other spare parts:

B-2474-1-36	Housing Sensor Stainless Steel
A-1016-A	Housing Sensor Bottom Assembly Stainless Steel
B-2762-B-1-36	Housing Sensor Upper Assembly Stainless Steel
MTR-1011	Meter Digital Panel LCD Backlight
ORNG-1007	O-ring 3/32 x 1-3/8 x 1-9/16 Viton
A-1161-A-5	PCB Assembly Main / Display
A-1162-AC	PCB Assembly AC Power Supply / Interconnection Alarms, 4-20mA Range ID
A-1162-DC	PCB Assembly DC Power Supply / Interconnection Alarms, 4-20mA Range ID
A-1175-AC	PCB Assembly AC Power Supply / Interconnection w/o Alarms, Relay Contacts Range ID
A-1175-DC	PCB Assembly DC Power Supply / Interconnection w/o Alarms, Relay Contacts Range ID



## 8 Troubleshooting

Symptom	Possible Cause	Recommended Action
Slow recovery	At installation, defective sensor  Air leak in sample system connection(s)  Abnormality in zero gas Damaged in service - prolonged exposure to air, electrolyte leak Sensor nearing end of life	Replace sensor if recovery unacceptable or O <sub>2</sub> reading fails to reach 10% of lowest range Leak test the entire sample system: Vary the flow rate, if the O <sub>2</sub> reading changes inversely with the change in flow rate indicates an air leak - correct source of leak Qualify zero gas (using portable analyzer) Replace sensor  Replace sensor
High O <sub>2</sub> reading after installing or replacing sensor	Analyzer calibrated before sensor stabilized caused by: 1) Prolonged exposure to ambient air, worse if sensor was <b>unshorted</b> 2) Air leak in sample system connection(s) 3) Abnormality in zero gas	Allow O <sub>2</sub> reading to stabilize before making the span/calibration adjustment Continue purge with zero gas  Leak test the entire sample system (above) Qualify zero gas (using portable analyzer)
High O <sub>2</sub> reading Sampling	Flow rate exceeds limits Pressurized sensor Improper sensor selection	Correct pressure and flow rate Remove restriction on vent line Replace GPR/PSR sensor with XLT sensor when CO <sub>2</sub> or acid gases are present
Response time slow	Air leak, dead legs, distance of sample line, low flow rate, volume of optional filters and scrubbers	Leak test (above), reduce dead volume or increase flow rate
O <sub>2</sub> reading doesn't agree to expected O <sub>2</sub> values	Pressure and temperature of the sample is different than span gas Abnormality in gas	Calibrate the analyzer (calibrate at pressure and temperature of sample) Qualify the gas (use a portable analyzer)

# ***Advanced Instruments Inc.***

---



---

<b>Symptom</b>	<b>Possible Cause</b>	<b>Recommended Action</b>
Erratic O <sub>2</sub> reading or No O <sub>2</sub> reading	Change in sample pressure	Sensors without PCB use mV setting. Calibrate the analyzer (calibrate at pressure and temperature of sample)
	Dirty electrical contacts in upper section of sensor housing	Clean contacts with alcohol (minimize exposure time of MS sensor to ambient air to extent possible)
	Corroded solder joints on sensor PCB from corrosive sample or electrolyte leakage from sensor	Replace sensor and return sensor to the factory for warranty determination
	Corroded spring loaded contact in upper section of sensor housing from liquid in sample or electrolyte leakage from sensor	Upper section of sensor housing: Clean contacts with alcohol, flow sample or zero gas for 2-3 hours to flush sample system and sensor housing Sensor: Replace if leaking and return it to the factory for warranty determination
	Liquid covering sensing area	Wipe with alcohol and lint free towel or flow sample or zero gas for 2-3 hours to flush Replace GPR/PSR sensor with XLT sensor when CO <sub>2</sub> or acid gases are present. Consult factory.
	Improper sensor selection	
	Presence of interference gases	Replace sensor and install scrubber
	Unauthorized maintenance	Consult factory.
	Sensor nearing end of life	Replace sensor
Erratic O <sub>2</sub> reading or Negative O <sub>2</sub> reading or No O <sub>2</sub> reading accompanied by electrolyte leakage	Pressurizing the sensor by flowing gas to the sensor with the vent restricted or SHUT OFF valve closed and suddenly removing the restriction draws a vacuum on the sensor	Zero the analyzer. If not successful replace the sensor
	or partially opening the valves upstream of the analyzer when using a pump downstream of the analyzer to draw sample from a process at atmospheric pressure or a slight vacuum. Placing a vacuum on the sensor in excess 4" of water column is strongly discouraged.	Avoid drawing a vacuum on the sensor, a pressurized sensor may not leak but still produce negative readings.
	A premature adjustment of the ZERO OFFSET potentiometer is a common problem	From MAIN MENU select DEFAULT ZERO

---



---

# Advanced Instruments Inc.

**Purpose: SPAN CALIBRATION** of digital (reference to analog) ppm O<sub>2</sub> analyzer already in-service.  
**TROUBLESHOOT** ppm O<sub>2</sub> analyzer to confirm response and stability under controlled conditions.

Preliminary Test

1.) Confirm metal sample system components - no plastic.  
 2.) Leak Test: Vary analyzer flow rate up/down and observe reading.

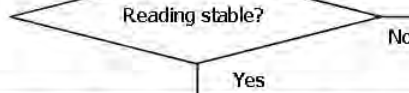

1.) Tighten and 'Snoop' connections  
 2.) STOP if reading is not stable and contact factory.

Set-up

1.) Place analyzer SAMPLE/BYPASS valve(s) in BYPASS mode, see (a) below.  
 2.) Select AUTO-RANGING mode or MANUALLY select range for span gas  
 3.) Perform DEFAULT ZERO or MANUALLY eliminate previous zero adjustments  
 4.) Perform DEFAULT SPAN  
 Note: Zeroing the analyzer is only recommended for continuous analysis < 1 ppm which normally excludes portable analyzers - constantly changing gas lines.

Connect Gas Line

1.) Connect the span gas line or if equipped with a 3-way SAMPLE/SPAN valve place it in the SPAN mode.  
 2.) Allow the span gas to flow for 5-10 minutes to purge the air (20.9% O<sub>2</sub>) from inside the span gas line - during connection or leaks during standby.

If analyzer is not equipped with BYPASS SAMPLE SYSTEM, see (a) below:  
 1.) Purge the span gas line before connecting to the analyzer.  
 2.) Connect the gas lines as quickly as possible - some air will be introduced.  
 3.) Allow extra time for the reading to stabilize - the sensor was exposed to air.  
 4.) When off-line, maintain gas flow thru analyzer or cap connections (inlet first) to avoid damaging the sensor by exposing it to air (20.9% O<sub>2</sub>).

Calibration Procedure

1.) Place analyzer SAMPLE/BYPASS valve(s) in SAMPLE mode, see (a) below.  
 2.) Allow the reading to stabilize, normally 2-10 minutes unless exposed to air.  
 3.) Once stable - initiate CALIBRATION routine (or unlock and adjust SPAN knob) from MAIN MENU, select SPAN CALIBRATE, enter SPAN VALUE, press ENTER.

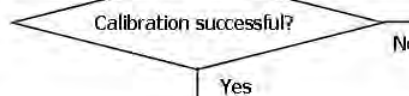

1.) Confirm span gas with portable analyzer calibrated with ambient air.  
 2.) Repeat at least twice.  
 3.) Replace sensor and repeat once.  
 4.) If unsuccessful with new sensor, STOP and contact factory.

Troubleshooting

Note: SPAN CALIBRATION is complete and for TROUBLESHOOTING purposes demonstrates the sensor/analyzer responds normally - under controlled conditions.  
 For TROUBLESHOOTING purposes only: Connect one of the analyzer's signal outputs to an external recording device and continue the flow of span gas for 1-2 hours.

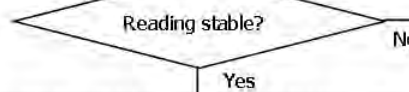

1.) Replace sensor and repeat once.  
 2.) If unsuccessful with new sensor, STOP and contact factory.

Sampling

1.) Place analyzer SAMPLE/BYPASS valve(s) in BYPASS mode, see (a) below.  
 2.) Connect Gas Line - as above for sample gas.  
 3.) Place analyzer SAMPLE/BYPASS valve(s) in SAMPLE mode, see (a) below.

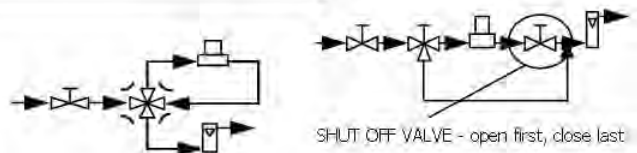

(a) Analyzer equipped (or supplied by user) with either type of BYPASS SAMPLE SYSTEM:

SHUT OFF VALVE - open first, close last

## 9 Warranty

The design and manufacture of GPR Series oxygen analyzers, monitors and oxygen sensors are performed under a certified Quality Assurance System that conforms to established standards and incorporates state of the art materials and components for superior performance and minimal cost of ownership. Prior to shipment every analyzer is thoroughly tested by the manufacturer and documented in the form of a Quality Control Certification that is included in the Owner's Manual accompanying every analyzer. When operated and maintained in accordance with the Owner's Manual, the units will provide many years of reliable service.

### **Coverage**

Under normal operating conditions, the monitor, analyzers and sensor are warranted to be free of defects in materials and workmanship for the period specified in accordance with the most recent published specifications, said period begins with the date of shipment by the manufacturer. The manufacturer information and serial number of this analyzer are located on the rear of the analyzer. Advanced Instruments Inc. reserves the right in its sole discretion to invalidate this warranty if the serial number does not appear on the analyzer.

If your Advanced Instruments Inc. monitor, analyzer and/or oxygen sensor is determined to be defective with respect to material and/or workmanship, we will repair it or, at our option, replace it at no charge to you. If we choose to repair your purchase, we may use new or reconditioned replacement parts. If we choose to replace your Advanced Instruments Inc. analyzer, we may replace it with a new or reconditioned one of the same or upgraded design. This warranty applies to all monitors, analyzers and sensors purchased worldwide. It is the only one we will give and it sets forth all our responsibilities. There are no other express warranties. This warranty is limited to the first customer who submits a claim for a given serial number and/or the above warranty period. Under no circumstances will the warranty extend to more than one customer or beyond the warranty period.

### **Limitations**

Advanced Instruments Inc. will not pay for: loss of time; inconvenience; loss of use of your Advanced Instruments Inc. analyzer or property damage caused by your Advanced Instruments Inc. analyzer or its failure to work; any special, incidental or consequential damages; or any damage resulting from alterations, misuse or abuse; lack of proper maintenance; unauthorized repair or modification of the analyzer; affixing of any attachment not provided with the analyzer or other failure to follow the Owner's Manual. Some states and provinces do not allow limitations on how an implied warranty lasts or the exclusion of incidental or consequential damages, these exclusions may not apply.

### **Exclusions**

This warranty does not cover installation; defects resulting from accidents; damage while in transit to our service location; damage resulting from alterations, misuse or abuse; lack of proper maintenance; unauthorized repair or modification of the analyzer; affixing of any label or attachment not provided with the analyzer; fire, flood, or acts of God; or other failure to follow the Owner's Manual.

### **Service**

Call Advanced Instruments Inc. at 909-392-6900 (or e-mail [info@aii1.com](mailto:info@aii1.com)) between 7:30 AM and 5:00 PM Pacific Time Monday thru Thursday or before 12:00 pm on Friday. Trained technicians will assist you in diagnosing the problem and arrange to supply you with the required parts. You may obtain warranty service by returning you analyzer, postage prepaid to:

Advanced Instruments Inc.  
2855 Metropolitan Place  
Pomona, Ca 91767 USA

Be sure to pack the analyzer securely. Include your name, address, telephone number, and a description of the operating problem. After repairing or, at our option, replacing your Advanced Instruments Inc. analyzer, we will ship it to you at no cost for parts and labor.

## 10 MSDS Material Safety Data Sheet

### Product Identification

Product Name	Oxygen Sensor Series - PSR, GPR, AII, XLT
Synonyms	Electrochemical Sensor, Galvanic Fuel Cell
Manufacturer	Analytical Industries Inc., 2855 Metropolitan Place, Pomona, CA 91767 USA
Emergency Phone Number	909-392-6900
Preparation / Revision Date	January 1, 1995
Notes	Oxygen sensors are sealed, contain protective coverings and in normal conditions do not present a health hazard. Information applies to electrolyte unless otherwise noted.

### Specific Generic Ingredients

Carcinogens at levels > 0.1%	None
Others at levels > 1.0%	Potassium Hydroxide or Acetic Acid, Lead
CAS Number	Potassium Hydroxide = KOH 1310-58-3 or Acetic Acid = 64-19-7, Lead = Pb 7439-92-1
Chemical (Synonym) and Family	Potassium Hydroxide (KOH) – Base or Acetic Acid (CH <sub>3</sub> CO <sub>2</sub> H) – Acid, Lead (Pb) – Metal

### General Requirements

Use	Potassium Hydroxide or Acetic Acid - electrolyte, Lead - anode
Handling	Rubber or latex gloves, safety glasses
Storage	Indefinitely

### Physical Properties

Boiling Point Range	KOH = 100 to 115° C or Acetic Acid = 100 to 117° C
Melting Point Range	KOH -10 to 0° C or Acetic Acid – NA, Lead 327° C
Freezing Point	KOH = -40 to -10° C or Acetic Acid = -40 to -10° C
Molecular Weight	KOH = 56 or Acetic Acid – NA, Lead = 207
Specific Gravity	KOH = 1.09 @ 20° C, Acetic Acid = 1.05 @ 20° C
Vapor Pressure	KOH = NA or Acetic Acid = 11.4 @ 20° C
Vapor Density	KOH – NA or Acetic Acid = 2.07
pH	KOH > 14 or Acetic Acid = 2-3
Solubility in H <sub>2</sub> O	Complete
% Volatiles by Volume	None
Evaporation Rate	Similar to water
Appearance and Odor	Aqueous solutions: KOH = Colorless, odorless or Acetic Acid = Colorless, vinegar-like odor

### Fire and Explosion Data

Flash and Fire Points	Not applicable
Flammable Limits	Not flammable
Extinguishing Method	Not applicable
Special Fire Fighting Procedures	Not applicable
Unusual Fire and Explosion Hazards	Not applicable

### Reactivity Data

Stability	Stable
Conditions Contributing to Instability	None
Incompatibility	KOH = Avoid contact with strong acids or Acetic Acid = Avoid contact with strong bases
Hazardous Decomposition Products	KOH = None or Acetic Acid = Emits toxic fumes when heated
Conditions to Avoid	KOH = None or Acetic Acid = Heat

## Spill or Leak

Steps if material is released

Sensor is packaged in a sealed plastic bag, check the sensor inside for electrolyte leakage. If the sensor leaks inside the plastic bag or inside an analyzer sensor housing do not remove it without rubber or latex gloves and safety glasses and a source of water. Flush or wipe all surfaces repeatedly with water or wet paper towel (fresh each time).

## Disposal

In accordance with federal, state and local regulations.

## Health Hazard Information

Primary Route(s) of Entry

Ingestion, eye and skin contact

Exposure Limits

Potassium Hydroxide - ACGIH TLV 2 mg/cubic meter or Acetic Acid - ACGIH TLV / OSHA PEL 10 ppm (TWA), Lead - OSHA PEL .05 mg/cubic meter

Ingestion

Electrolyte could be harmful or fatal if swallowed. KOH = Oral LD50 (RAT) = 2433 mg/kg or Acetic Acid = Oral LD50 (RAT) = 6620 mg/kg

Eye

Electrolyte is corrosive and eye contact could result in permanent loss of vision.

Skin

Electrolyte is corrosive and skin contact could result in a chemical burn.

Inhalation

Liquid inhalation is unlikely.

Symptoms

Eye contact - burning sensation. Skin contact - soapy slick feeling.

Medical Conditions Aggravated

None

Carcinogenic Reference Data

KOH and Acetic Acid = NTP Annual Report on Carcinogens - not listed; LARC Monographs - not listed; OSHA - not listed

Other

Lead is listed as a chemical known to the State of California to cause birth defects or other reproductive harm.

## Special Protection Information

Ventilation Requirements

None

Eye

Safety glasses

Hand

Rubber or latex gloves

Respirator Type

Not applicable

Other Special Protection

None

## Special Precautions

Precautions

Do not remove the sensor's protective Teflon and PCB coverings. Do not probe the sensor with sharp objects. Wash hands thoroughly after handling. Avoid contact with eyes, skin and clothing. Empty sensor body may contain hazardous residue.

Transportation

Not applicable

## Appendix B

### Correlating Readings - LCD Display and 4-20mA Output

In rare instances the 4-20mA signal output may not agree to the reading displayed by the LCD. The Output Zero and Output Span features enable the user to adjust the 4mA signal output to correlate with the reading displayed by the LCD.

For optimum accuracy make two separate adjustments as follows:

1. OUTPUT ZERO feature: To adjust the 4mA signal output and requires zero gas.
2. OUTPUT SPAN feature: To adjust the 20mA signal output and requires span gas near full range.

In the field or in the absence of the preferred gases, use the OUTPUT SPAN feature and adjust the 20mA signal output using the span gas available.

#### Procedure – regardless of type of adjustment:

1. The microprocessor defaults to 100% to start.
2. The "actual" 4-20mA signal output will be adjusted to the "theoretical" value of the LCD display.
3. Adjustment general rule:
  - a) If the actual 4-20mA value < the theoretical LCD value, the adjustment value will be > 100%.
  - b) If the actual 4-20mA value > the theoretical LCD value, the adjustment value will be < 100%.
4. Convert the "actual" reading of the LCD display to the "theoretical" 4-20mA as follows:
  - a) Divide the "actual" (ppm or percent) LCD reading by the value of the span gas available.
  - b) Multiply 16mA (20mA – 4mA) times the "result of a."
  - c) Add 4mA plus the "result of b." to obtain the "theoretical" 4-20mA signal output value.
5. Adjustment value: Divide the theoretical by the actual 4-20mA values and multiply by 100.
6. Enter the adjustment value via OUTPUT ZERO or OUTPUT SPAN routines described below.

**Example:** Analyzer reading is 60 ppm oxygen (100 ppm range) on 84 ppm span gas, 4-20mA signal output at PLC is 24mA

- Solution:**
- a) Use OUTPUT SPAN feature to make the adjustment.
  - b) Adjustment will be < 100% (default value of OUTPUT SPAN feature).
  - c) 13.6mA is the "theoretical" 4-20mA converted from the "actual" reading of the LCD.  
 $60 \text{ ppm} \div 84 \text{ ppm} = 0.71 \text{ or } 71\%$   
 $16\text{mA} \times 0.71 = 11.36\text{mA}$   
 $4\text{mA} + 11.36\text{mA} = 15.36\text{mA}$  "theoretical" 4-20mA signal output value
  - d)  $15.36\text{mA} \div 24\text{mA}$  the "actual" 4-20mA value = 64.0 adjustment value
  - e) Enter 64.0 via OUTPUT SPAN procedure below.

#### Output Zero

7. Access the MAIN MENU by pressing the MENU key.
8. Advance the reverse shade cursor using the ARROW keys to highlight CALIBRATION.
9. Press the ENTER key to select the highlighted menu option.
10. The following displays appear:

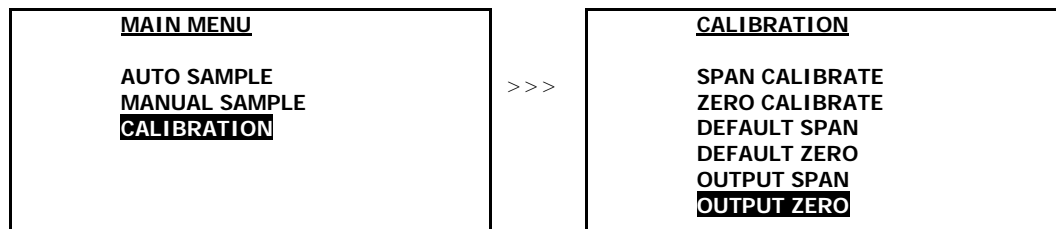

11. Advance the reverse shade cursor using the ARROW keys to highlight DEFAULT ZERO.
12. Press the ENTER key to select the highlighted menu option.
13. The following display appears:

100.0  
OUTPUT ZERO OFFSET  
  
PRESS UP OR DOWN  
TO CHANGE VALUE  
ENTER TO SAVE  
MENU TO RETURN

14. Enter the calculated adjustment value. **Note:** Once the initial adjustment is made and checked at the PLC it may be necessary to fine tune the initial adjustment by repeating. Any additional percent error must be added or subtracted from the initial adjustment value

000.0  
OUTPUT ZERO OFFSET  
  
PRESS UP OR DOWN  
TO CHANGE VALUE  
ENTER TO SAVE  
MENU TO RETURN

15. Press the ENTER key to advance the underline cursor right or press the MENU key to advance the underline cursor left to reach to the desired digit of the adjustment OUTPUT ZERO OFFSET value.  
16. Press the ARROW keys to enter each the numerical value of each digit of the adjustment OUTPUT ZERO OFFSET value.  
17. Repeat until the complete OUTPUT ZERO OFFSET value has been entered.  
18. **Save the adjustment value by pressing the ENTER key or abort by pressing the MENU key.**  
19. The system returns to the SAMPLING mode.

## Output Span

20. Access the MAIN MENU by pressing the MENU key.  
21. Advance the reverse shade cursor using the ARROW keys to highlight CALIBRATION.  
22. Press the ENTER key to select the highlighted menu option.  
23. The following displays appear:

<p><u>MAIN MENU</u>  AUTO SAMPLE MANUAL SAMPLE <u>CALIBRATION</u></p>	>>>	<p><u>CALIBRATION</u>  SPAN CALIBRATE ZERO CALIBRATE DEFAULT SPAN DEFAULT ZERO <u>OUTPUT SPAN</u> OUTPUT ZERO</p>
---	-----	---

24. Advance the reverse shade cursor using the ARROW keys to highlight OUTPUT SPAN.  
25. Press the ENTER key to select the highlighted menu option.  
26. The following display appears:

100.0  
OUTPUT SPAN OFFSET  
  
PRESS UP OR DOWN  
TO CHANGE VALUE  
ENTER TO SAVE  
MENU TO RETURN



27. Enter the calculated adjustment value, refer to example described above. **Note:** Once the initial adjustment is made and checked at the PLC it may be necessary to fine tune the initial adjustment by repeating. Any additional percent error must be added or subtracted from the initial adjustment value

<p><b>06<u>4</u>.0</b></p> <p><b>OUTPUT SPAN OFFSET</b></p> <p><b>PRESS UP OR DOWN TO CHANGE VALUE</b></p> <p><b>ENTER TO SAVE</b></p> <p><b>MENU TO RETURN</b></p>
---

28. Press the ENTER key to advance the underline cursor right or press the MENU key to advance the underline cursor left to reach to the desired digit of the adjustment OUTPUT SPAN OFFSET value.
29. Press the ARROW keys to enter the numerical value of each digit of the OUTPUT SPAN OFFSET value.
30. Repeat until the complete OUTPUT SPAN OFFSET value has been entered.
31. **Save the adjustment value by pressing the ENTER key or abort by pressing the MENU key.**
32. The system returns to the SAMPLING mode.